

SAC1300S

SANY All Terrain Crane
130 Tons Lifting Capacity



Max. Lifting Capacity: 130 t
Max. Boom Length: 63 m
Max. Lifting Height: 92.5 m

Efficient Power System

- The carrier power is transmitted mechanically to superstructure. The structure is simple, safe and reliable, with low fault rate;
- Single-engine power system is adopted for weight reduction of the superstructure power system and enhancement of the load-bearing components, increasing crane lifting performance by 20%.

Excellent lifting performance

- 7-section telescoping boom with single cylinder pin. The total boom length is 63m, and jib length is 33.5m;
- Maximum lifting height is 92.5m and maximum working radius is 70m, ensuring a wider working range;
- Maximum lifting torque of basic boom is 4547kN.m, featuring superior lifting and loading performance.

Mobile and flexible carrier

- The crane is 14m long and 2.8m wide, with strong adaptability to construction site;
- 5-axle all-wheel steering and 8.5m minimum turning radius, ensuring flexible movement of the crane;
- With a powerful carrier, the maximum travel speed is 85km/h, and the maximum gradient can reach up to 60%;
- When travelling in the state of 60T, it can carry counterweight or parts to up 5T.

Safe control system

- Equipped with an anti-tipping warning system, advance warning is issued through sound and light notice to ensure the safety of crane;
- Equipped with a voice alarm system, voice notices are issued for various movement to prevent mis-operation and ensure safety of personnel and operation;
- High-accuracy, high-stability, high-intelligence load moment limiter system is adopted for full protection of lifting and loading operation;
- The abundant sensors give timely feedback of data information and realize real-time monitoring.



Energy-saving hydraulic system

- The application of electrically controlled variable displacement pump, displacement and speed grade control technology increase working efficiency by 15%, while saving energy by 20%;
- With dual pump converging / diverging intelligent speed regulation technology, the dual pump supplies oil independently for compound movements, which ensures the stability and reliability of the movements with better micro-mobility. The various diverging distribution mode makes work freer and easier;
- The dual protection of winching, luffing, telescoping on the hydraulic circuit makes operation safer and more reliable.



Overall Dimensions

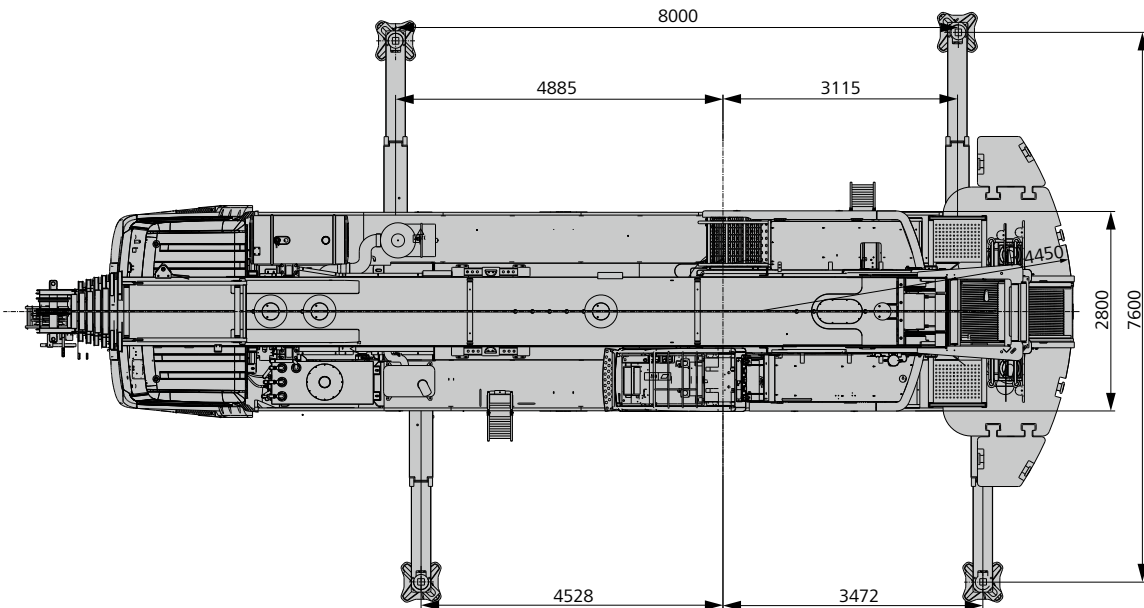
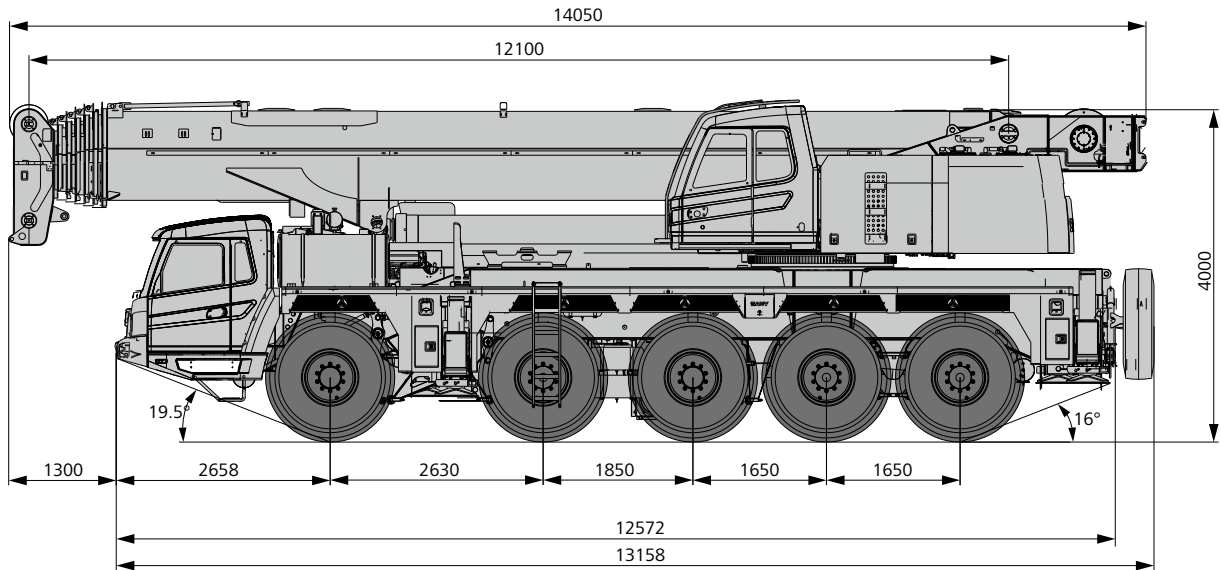

Technical Parameters

Type	Item	Unit	Parameter	
Dimensions	Overall length	mm	14050	
	Overall width	mm	2800	
	Overall height	mm	4000	
Weight	Total weight of crane	kg	55000	
	Axle load	Load of axle 1, axle 2	kg	23000
		Load of axle 3, axle 4, axle 5	kg	32000
Power	Engine model	OM460LA.E3A/1		
	Max. engine power	Kw/rpm	360/1800	
	Max. engine output torque	N.m/rpm	2200/1300	
Travel	Max. travel speed	Km/h	85	
	Min. turning radius	m	8.5	
	Min. ground clearance	mm	285	
	Min. turning radius of boom head	m	11	
	Approach angle	°	19.5	
	Departure angle	°	16	
	Braking distance (at 30km/h)	m	10	
	Max. grade ability	%	60	
Performance specifications	Max lifting capacity	t	130	
	Min. rated radius	m	3	
	Max. turntable swing radius	mm	4450	
	Max. Lifting torque	Min. boom length	kN.m	4547
		Max. boom length	kN.m	1999
		Max. boom length + jib	kN.m	1037
	Transverse outrigger span	m	8.0x7.6	
	Lifting height	Min. boom length	m	12.6
		Max. boom length	m	63.5
		Max. boom length + jib	m	79
		Max. boom + jib + optional standard section	m	92.5
	Boom length	Min. boom length	m	12.1
		Max. boom length	m	63
		Max. boom length + jib	m	78.5
Max. boom + jib + optional standard section		m	92.4	
Jib offset angle	°	0,15,30		
Working speed	Max speed, main hoist, single line, no load	m/min	130	
	Max speed, aux hoist, single line, no load	m/min	130	
	Boom fully extending / Retracting time	s	550/500	
	Boom raising / Lowering time	s	50/175	
	Slewing speed	r/min	1.5	
	Outrigger beam fully extending / Retracting time	s	30/25	
	Outrigger jack's fully extending / Retracting time	s	35/30	

Technical Parameters



Axle load

Axle	1	2	3	4	5	Overall mass
Axle load / t	11.5	11.7	10.4	10.7	10.7	55
Remarks	-					



Hook and multiplying power

Rated load / t	Pulleys	Number of parts of line	Hook weight / kg
80	3	7	693
12.5	/	1	270

Crane Introduction

No	Name	Manufacture
1	Transfer case	Kessler
2	Engine	Benz
3	Transmission	ZF
4	Axle 1	KESSLER
5	Axle 2	KESSLER
6	Axle 3	KESSLER
7	Axle 4	KESSLER
8	Axle 5	KESSLER
9	Tire	Tecking
10	Piston pump	Rexroth
11	Winch motor	Kawasaki

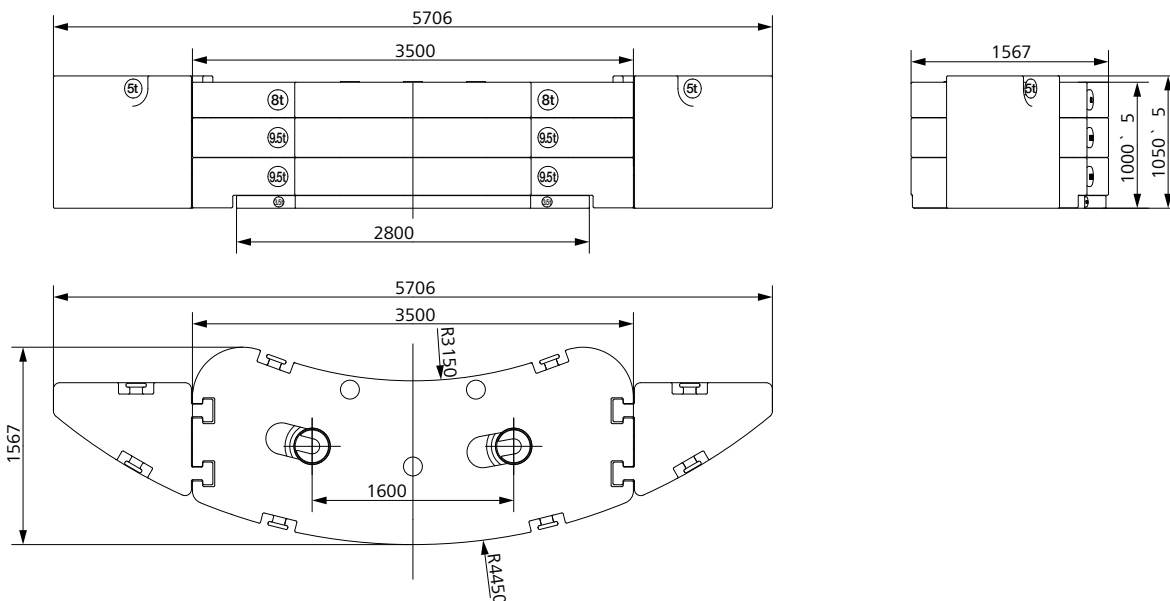

Crane Introduction

Driving cab

- The driver cab is of new steel structure independently developed by SANY and characterized by excellent shock absorption and sealing performance, with the outward-opening doors on both sides, driver's seat and passenger seat with pneumatic suspension, adjustable steering wheel, large-vision rearview mirror, comfortable driver's seat with headrest, fog-proof fan, air conditioner, stereo radio as well as complete control instruments, thus ensuring more comfort, safety and user-friendliness.

Crane frame

- The frame is designed and manufactured by SANY. It is of anti-twisting box-type structure welded by fine-grain high-strength steel plates, with a strong bearing capacity.

Chassis engine: Single-engine mechanical drive

- Type: Electronically controlled, six-in-line, water cooled, supercharged intercooled, electronically injected diesel engine.
- Output power: 360 kw/1,800 rpm.
- Max. torque: 2,200 Nm/1,300 rpm.
- Environmental protection property: Up to Euro III emission standard.
- Fuel tank capacity: About 500 L.

Gearbox

- The manual / automatic 12-speed gearbox with a wide speed ratio range can meet the requirements for low-speed site climbing and high-speed traveling.

Axle

- All axles are used for steering, and the 2nd, 4th and 5th axles for drive. The 1st and 2nd axles are equipped with the hydraulic power steering gear characterized by linkage feedback, and the 3rd, 4th and 5th axles are configured with the electro-hydraulic control steering system, which enables auxiliary speed control and optional special steering, thus achieving easy steering and flexible manipulation.

Steering / drive

- 10 × 6.

Suspension system

- All axles are equipped with hydro-pneumatic suspensions, with an adjustable height and a hydraulic interlocking function. The suspension height can be adjusted for 200 mm and 100 mm in the upward and downward directions respectively. The crane has the suspension, rigid locking, automatic leveling, overall lifting, single-point lifting modes so that it can adapt to various poor working and road conditions, thus guaranteeing the traveling smoothness, roll stability and driving comfort.

Tire

- Tecking, 10 × 14.00R25, meridian vacuum tyre.

Braking system

- Parking brake: Driven by the accumulator and acted on the 2nd, 3rd, 4th and 5th axles.
- Service brake: All wheels are equipped with the air servo brake, double circuit braking system and disc brake.
- Auxiliary brake: The engine is equipped with the engine brake and exhaust brake to decelerate the crane in advance, which can reduce the wear of brake components and save the cost.

Steering system

- The servo power steering gear and double circuit hydraulic steering system are used, with an emergency steering pump.
- There are 5 steering modes: 1) Road traveling mode (default mode); 2) All-wheel steering mode; 3) Crab mode; 4) Deflection-free steering mode; 5) Independent rear axle steering mode.

Outrigger

- It has a 4-point support, with a longitudinal / transverse span of 8.0 m × 7.6 m, a telescopic system of full-hydraulic horizontal / vertical outrigger cylinder and an automatic leveling function.

Electrical equipment

- A modern data bus system, a 24V DC power supply and 2 groups of battery pack (each of which is 180AH) are used to power off the lowerstructure.
- The chassis is equipped with a CAN bus system; a multi-function centralized display system is used; the power consumption is low, and the maximum power is 5 W; the user interface has four function keys; a LCD display is used, with adjustable contrast.

Crane Introduction

Operating cab

- Corrosion-resistant steel plates are used, and the user-friendly design including fully-covered softened interior trims, panoramic sunroof and adjustable seats is configured, thus ensuring more comfortable and easier operation; a torque limiter display is equipped and the main console and operation display system are combined so that all data of hoisting operation are clear.

Boom system

- Boom:** It is comprised of 7 sections, with the base boom length of 12.1 m, fully-extended boom length of 63 m and fully-extended boom lifting height of 63.5 m, and made of fine-grain high-strength steel, with a U-shaped section.
- Jib:** It consists of 5 sections, with a total length of 33.5 m and a mechanical luffing of 0°/15°/30°.
- Telescopic mechanism:** The independent hydraulically driven telescopic mechanism is used, with a full extension / retraction duration of 550/500 s, thus ensuring high efficiency, safety and reliability.

Slewing system

- The slewing system can achieve 360° slewing at a speed of 0 ~ 1.5 r/min, with 1 closed proportional variable pump and 2 hydraulic fixed-displacement axial piston motors. The electro-hydraulic proportional closed hydraulic circuit and electro-hydraulic proportional pedal are used, which can achieve emergency brake.

Turntable structure

- The turntable independently developed by SANY has an optimized structure. It is made of fine-grain high-strength steel.

Superstructure hydraulic system

- High-quality key hydraulic components including the main oil pump, slewing pump, main valve, hoist motor and balance valve are used, thus ensuring the stability and safety of the hydraulic system; accurate parameter matching provides more superior operation performance; the electro-hydraulic proportional variable-displacement piston pump is used to achieve real-time adjustment of the oil pump displacement and high-precision flow control through the change of the opening of the electronically-controlled handle, thus ensuring no energy loss during operation; the independently developed dual-pump main converging / diversion valve is used, thus achieving higher single-action dual-pump converging efficiency and better combined-action dual-pump diversion maneuverability.
- The deadweight descending amplitude compensating hydraulic system is used thus ensuring higher stability.
- The extension and retraction of the boom is achieved through a single-cylinder cross pin telescopic system.
- The mechanical luffing of 0° / 15° / 30° of the jib is achieved.
- The closed slewing system is used to adjust the flow and direction through the adjustment of the angle of the variable pump swash plate, thus ensuring excellent inching performance and stable slewing.
- Hydraulic oil tank capacity: 710L.

Crane Introduction



Lifting mechanism

- The main winch is equipped with an electro-hydraulic proportional variable-displacement motor, which ensures good inching performance and stability. The wire ropes of the main and auxiliary winches have a diameter of 22 mm, and their lengths are 280 m and 190 m respectively.



Luffing mechanism

- The deadweight descending system guarantees higher energy efficiency. The single cylinder and front hinged support are used, which saves the luffing effort and improves the force applied to the boom; the electro-hydraulic proportional control balance valve is adopted. The luffing angle is $-1^{\circ} \sim 81^{\circ}$.



Control system

- The SYMC torque limiter system independently developed by SANY is used for electronic control (PLC control) of the crane; two multi-directional handles are used for automatic reset; the movement of the crane is adjusted through the adjustment of the hydraulic pump. The speed is regulated through the adjustment of the engine speed.



Safety device

- Torque limiter: Based on the analytical mechanics method, the torque limiter calculation system based on the lifting force model is established. Through the on-line no-load calibration, the rated lifting speed is $\pm 3\%$, and the full-load protection is carried out. Automatic alarm tips, to provide security for the operation of security.
- The hydraulic system is configured with the hydraulic balance valve, overflow valve, two-way hydraulic lock and other components to achieve stability and reliability.
- The main / auxiliary winch is equipped with a three-ring protector to avoid excessive release of wire ropes.
- The boom / jib end is equipped with a height limiter to avoid excessive winding of wire ropes.
- The boom end is installed with an anemometer to check whether the high altitude wind speed is beyond the allowable operation range.



Counterweight

- The combined variable counterweights, total weight 40.5 t. The counterweight is ascended and descended through wireless remote control, thus ensuring good inching performance.



Optional

- Auxiliary winch;
- Hook (125t);
- Outrigger pad;
- 2 pcs of 6m jib extension;
- 1 pcs of 6m boom extension (2 pcs of 6m jib extension necessary).

Boom Operating Range

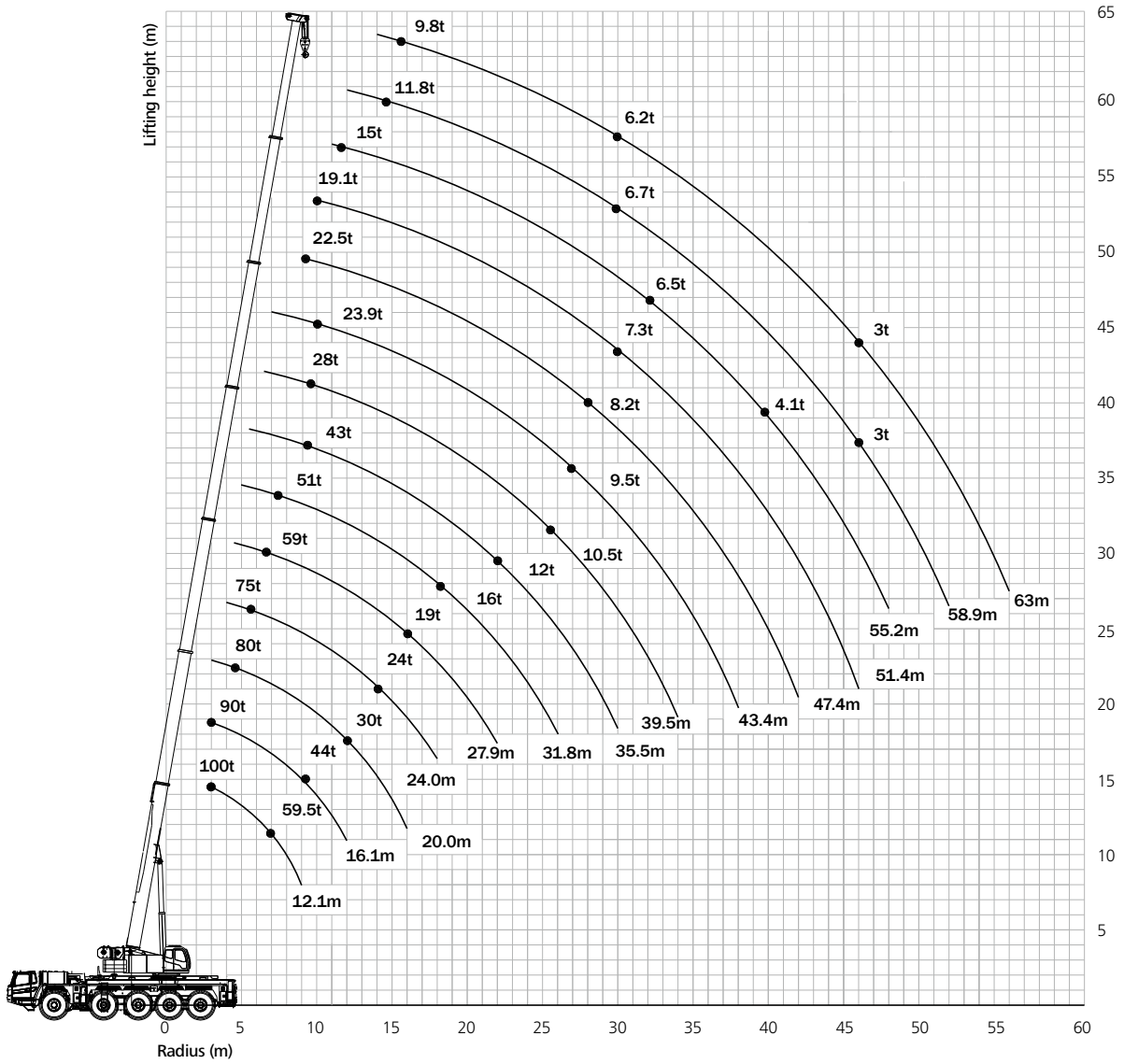

Load Chart - Telescopic Boom

Unit: t

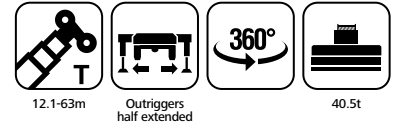

Radius (m)	12.1	16.1	20	24	27.8	31.8	35.5	Radius (m)
3	130	100	75					3
3.5	100	95	69	92	71			3.5
4	98	90.5	65	90	66.5	85	54.3	4
4.5	90	84	61	84.5	62.5	82	51.7	4.5
5	85	79	57	79	59	79	49.3	5
6	74	70	51	69.5	52.5	70	45.5	6
7	57	55.6	46	57	47.5	57.8	41.3	7
8	45.4	44.2	41.5	45.5	43	46.2	37.3	8
9	37.5	36.3	38.5	37.5	39.2	38.2	34.3	9
10		30.5	32.7	31.7	33.3	32.3	31.5	10
11		26.1	28.2	27.2	28.8	27.8	29.5	11
12		22.6	24.7	23.7	25.2	24.3	26	12
14				18.5	20	19.1	20.6	14
16				15	16.3	15.4	17	16
18						12.7	14.2	18
20						11.2	12	20
22						9.5	10.4	22
24								24
26								26
28								28
30								30
32								32
34								34
36								36
38								38
40								40
42								42
44								44
46								46
48								48
50								50
52								52
54								54
56								56
58								58
60								60
II		46						II
III				46		46		III
IV				46		46		IV
V				46	46	46		V
VI			46	46		46		VI
VII						46		VII
Number of parts of line	12	11	11	10	10	9	9	Number of parts of line

Load Chart - Telescopic Boom

Unit: t

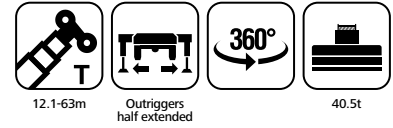

Radius (m)	39.5			43.4			47.4			51.3			55		58.9		63	Radius (m)
3																		3
3.5																		3.5
4																		4
4.5																		4.5
5																		5
6																		6
7	41	29.5	39	32	32													7
8	38	27.5	37	31	31	27.5												8
9	35	25.8	35	29	29	25.6	25.6	23	21.5									9
10	32.6	24.2	31.9	28	28	24	24.5	22	20	20.5	20.5	16.8						10
11	28.1	22.7	27.4	26.5	26.5	22.5	23	20.5	19	19.5	19.5	16.1	15	17				11
12	24.5	21.5	23.9	24.5	24.1	21	21.6	19.5	18	18.5	18.5	15.5	14.5	16.5	14			12
14	19.3	19.2	18.6	19.2	18.9	19	19.3	17.5	16.5	16.5	16.8	14	13.5	15	13	11.2		14
16	15.6	16.4	15	15.5	15.2	16.2	15.7	16	14.5	15.5	15.2	13	12.5	13.7	12	10.6		16
18	12.9	13.7	12.3	12.8	12.5	13.4	13	13.4	13	13.2	13.1	11.7	11.5	12.6	11	10.1		18
20	10.8	11.6	10.2	10.7	10.3	11.3	10.8	11.2	12	11.1	11	10.7	10.5	11.3	10.5	9.4		20
22	9.1	9.9	8.5	9	8.7	9.6	9.1	9.5	10.2	9.4	9.3	10	10	9.6	9.7	8.8		22
24	7.7	8.5	7.2	7.7	7.3	8.3	7.8	8.2	8.8	8	8	9.2	8.9	8.2	8.5	8.3		24
26	6.6	7.4	6	6.5	6.2	7.1	6.7	7	7.7	6.9	6.8	8	7.7	7.1	7.4	7.4		26
28	5.7	6.5	5.1	5.6	5.3	6.2	5.7	6.1	6.7	5.9	5.8	7	6.7	6.2	6.4	6.4		28
30	4.9	5.7	4.2	4.8	4.4	5.4	4.9	5.3	5.9	5.1	5	6.2	5.9	5.3	5.6	5.6		30
32	4.1	5	3.5	4	3.6	4.7	4.1	4.6	5.2	4.4	4.3	5.5	5.2	4.6	4.9	4.9		32
34	3.5	4.4	2.8	3.3	2.9	4.1	3.5	3.9	4.6	3.7	3.6	4.9	4.5	4	4.2	4.3		34
36				2.7	2.3	3.5	2.8	3.3	4	3.1	3	4.3	4	3.4	3.7	3.7		36
38				2.2	1.8	3	2.3	2.8	3.5	2.5	2.5	3.8	3.5	2.8	3.1	3.1		38
40							1.8	2.3	3.1	2	2	3.4	3	2.3	2.6	2.6		40
42							1.4	1.9	2.7	1.6	1.6	3	2.6	1.9	2.2	2.2		42
44												2.6	2.2	1.5	1.8	1.8		44
46												2.3	1.8	1.1	1.5	1.5		46
48												1.5						48
50																		50
52																		52
54																		54
56																		56
58																		58
60																		60
II	92	46	92	92	92	46	92	46		92	92		46	92	92	100		II
III	46	46	92	92	92	46	92	92	92	92	92	92	92	92	92	100		III
IV	46	46	46	46	92	92	92	92	92	92	92	92	92	92	92	100		IV
V	46	46	46	46	46	92	46	92	92	92	92	92	92	92	92	100		V
VI	46	46	46	46	46	92	46	92	92	46	92	92	92	92	92	100		VI
VII	46	92		46			46		46	46		92	92	46	92	100		VII
Number of parts of line	5	5	5	4	4	4	3	3	3	2	2	2	2	2	2	2		Number of parts of line

Load Chart - Telescopic Boom

Unit: t

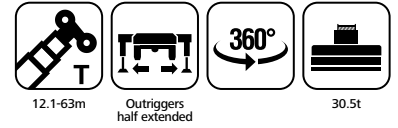

Radius (m)	12.1	16.1	20	24	27.8	31.8	35.5	Radius (m)
3	130	95	75					3
3.5	100	95	69	92	71			3.5
4	98	90	65	90	66.5	85	54.3	4
4.5	90	84	61	84	62.5	82	51.7	4.5
5	82	79	57	79	59	79	49.3	5
6	62.5	61.5	51	62.5	52.5	63.5	45.5	6
7	47	46.2	45.5	47.5	47.5	48	41.3	7
8	37.5	36.5	39	37.5	39.5	38	37.3	8
9	30.7	29.8	32.2	31	32.7	31.5	33.5	9
10		25	27.2	26	27.6	26.5	28.4	10
11		21.2	23.5	22.2	23.8	22.8	24.6	11
12		18.3	20.5	19.2	20.8	19.8	21.5	12
14				15	16.4	15.4	17	14
16				11.8	13.2	12.3	13.9	16
18						10	11.6	18
20						8.7	9.7	20
22						7.2	8.3	22
24								24
26								26
28								28
30								30
32								32
34								34
36								36
38								38
40								40
42								42
44								44
46								46
48								48
50								50
52								52
54								54
56								56
58								58
60								60
II		46						II
III				46		46		III
IV				46		46		IV
V					46	46		V
VI			46		46	46		VI
VII						46		VII
Number of parts of line	12	11	11	10	10	9	9	Number of parts of line

Load Chart - Telescopic Boom

Unit: t

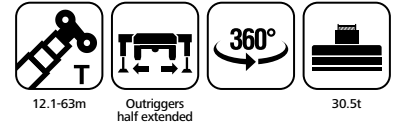

Radius (m)	39.5			43.4			47.4			51.3			55		58.9		63	Radius (m)
3																		3
3.5																		3.5
4																		4
4.5																		4.5
5																		5
6																		6
7	41	29.5	39	32	32													7
8	38	27.5	37	31	31	27.5												8
9	32	25.8	31.2	29	29	25.6	25.6	23	21.5									9
10	27	24.2	26.2	27	26.5	24	24.5	22	20	20.5	20.5	16.8						10
11	23.1	22.7	22.5	23	22.7	22.5	23	20.5	19	19.5	19.5	16.1	15	17				11
12	20.1	21	19.5	20	19.7	20.8	20.2	19.5	18	18.5	18.5	15.5	14.5	16.5	14			12
14	15.7	16.5	15	15.6	15.2	16.3	15.8	16.2	16.5	16	16	14	13.5	15	13	11.2		14
16	12.5	13.4	12	12.5	12.1	13.1	12.6	13.1	13.8	12.9	12.8	13	12.5	13.2	12	10.6		16
18	10.2	11	9.6	10.2	9.8	10.8	10.3	10.7	11.4	10.6	10.5	11.7	11.4	10.8	11	10.1		18
20	8.5	9.2	7.8	8.4	8	9	8.5	8.9	9.6	8.8	8.7	10	9.6	9	9.3	9.3		20
22	7	7.8	6.3	6.9	6.5	7.6	7	7.5	8.2	7.2	7.1	8.5	8.1	7.6	7.8	7.8		22
24	5.7	6.6	5	5.6	5.1	6.4	5.7	6.2	7	5.9	5.8	7.3	7	6.3	6.6	6.6		24
26	4.6	5.6	3.8	4.5	4	5.3	4.6	5.1	6	4.8	4.7	6.3	6	5.2	5.5	5.5		26
28	3.7	4.7	2.9	3.6	3.1	4.4	3.7	4.2	5.1	3.9	3.8	5.4	5	4.3	4.6	4.6		28
30	2.9	3.9	2.1	2.8	2.3	3.6	2.9	3.4	4.3	3.1	3	4.6	4.2	3.5	3.8	3.8		30
32	2.2	3.3	1.5	2.1	1.6	2.9	2.2	2.7	3.6	2.4	2.3	3.9	3.5	2.8	3.1	3.1		32
34	1.6	2.7		1.5		2.3	1.6	2.1	3	1.8	1.7	3.3	2.9	2.2	2.5	2.5		34
36						1.8		1.6	2.5	1.3	1.2	2.8	2.4	1.7	2	2		36
38						1.3			2			2.3	1.9	1.2	1.5	1.5		38
40									1.6			1.9	1.5					40
42									1.2			1.5						42
44																		44
46																		46
48																		48
50																		50
52																		52
54																		54
56																		56
58																		58
60																		60
II	92	46	92	92	92	46	92	46		92	92		46	92	92	100		II
III	46	46	92	92	92	46	92	92	92	92	92	92	92	92	92	100		III
IV	46	46	46	46	92	92	92	92	92	92	92	92	92	92	92	100		IV
V	46	46	46	46	46	92	46	92	92	92	92	92	92	92	92	100		V
VI	46	46	46	46	46	92	46	92	92	46	92	92	92	92	92	100		VI
VII	46	92		46			46		46	46		92	92	46	92	100		VII
Number of parts of line	5	5	5	4	4	4	3	3	3	3	3	3	2	2	2	2		Number of parts of line

Load Chart - Telescopic Boom

Unit: t

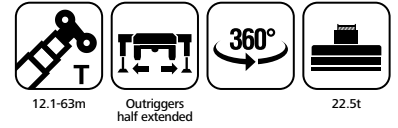

Radius (m)	12.1	16.1			20		24		27.8			31.8			35.5			Radius (m)
3	130	95	75															3
3.5	100	95	69	92	71													3.5
4	98	90	65	90	66.5	84	54.3											4
4.5	90	84	61	84	62.5	82	51.7	75	56	80								4.5
5	76	75	57	76.5	59	77.5	49.3	73	54.2	75	68	56	60					5
6	52.3	51.3	51	52.8	52.5	53.6	45.5	54.5	50	53	53.5	53	53.5	52	43	35.3		6
7	39.3	38.3	41	39.6	41.6	40.4	41	41.2	42.5	39.7	40.5	42	40.2	41.3	39.5	32.3		7
8	31	30	32.5	31.3	33.1	32	34	32.7	34	31.3	32	33.5	31.8	32.8	33.2	29.7		8
9	25.2	24.4	26.7	25.6	27.2	26.2	28.1	26.9	28	25.6	26.2	27.5	26	27	27.3	27		9
10		20.2	22.5	21.3	23	22	23.7	22.6	23.6	21.3	22	23.2	21.8	22.6	23	23.8		10
11		17	19.2	18.1	19.7	18.7	20.4	19.3	20.3	18.1	18.7	20	18.5	19.4	19.7	20.5		11
12		14.5	16.6	15.6	17.1	16.1	17.8	16.7	17.7	15.6	16.2	17.3	16	16.8	17.1	17.8		12
14				11.8	13.3	12.4	14	12.9	13.8	11.8	12.4	13.5	12.2	13	13.2	14		14
16				9.2	10.6	9.5	11.2	10.2	11.1	9	9.6	10.8	9.5	10.3	10.5	11.2		16
18						7.5	9.3	8.2	9.1	7	7.7	8.8	7.5	8.2	8.6	9.2		18
20								6.5	7.5	5.5	6.1	7.1	5.9	6.7	7	7.7		20
22								5.2	6.2	4.1	4.7	6	4.5	5.3	5.6	6.5		22
24											3.6	5	3.4	4.2	4.6	5.4		24
26											2.7	4	2.5	3.3	3.7	4.5		26
28														2.5	2.9	3.7		28
30														1.9	2.3	3.1		30
32																		32
34																		34
36																		36
38																		38
40																		40
42																		42
44																		44
46																		46
48																		48
50																		50
52																		52
54																		54
56																		56
58																		58
60																		60
II		46								46	46		46	46				II
III				46		46		46		46	46	46	46	46	92	46		III
IV				46		46		46	46	46	46	46	46	46	46	46		IV
V					46	46	46	46	46	46	46	46	92	46	46	46		V
VI			46		46		46	46	46		46	46		46	46	46		VI
VII							46	46	46		46	46		46	46	92		VII
Number of parts of line	12	11	11	10	10	9	9	8	8	8	7	7	7	6	6	6		Number of parts of line

Load Chart - Telescopic Boom

Unit: t

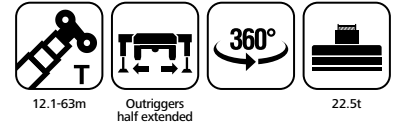

Radius (m)	39.5			43.4			47.4			51.3			55		58.9		63	Radius (m)
3																		3
3.5																		3.5
4																		4
4.5																		4.5
5																		5
6																		6
7	41	29.5	39	32	32													7
8	32.3	27.5	31.5	31	31	27.5												8
9	26.5	25.8	25.8	26.4	26	25.6	25.6	23	21.5									9
10	22.2	23.2	21.5	22.2	21.8	23	22.3	22	20	20.5	20.5	16.8						10
11	19	20	18.3	19	18.5	19.6	19.1	19.5	19	19	19	16.1	15	17				11
12	16.4	17.3	15.7	16.3	16	17	16.5	17	17.7	16.8	16.7	15.5	14.5	16.5	14			12
14	12.6	13.5	12	12.5	12.1	13.2	12.6	13.1	13.9	13	12.9	14	13.5	13.2	13	11.2		14
16	10	10.8	9.3	9.8	9.5	10.5	10	10.4	11.1	10.2	10.2	11.5	11.1	10.5	10.8	10.6		16
18	8	8.8	7.2	7.7	7.3	8.5	7.8	8.4	9.1	8.1	8.1	9.5	9.1	8.4	8.8	8.8		18
20	6.2	7.2	5.6	6	5.7	7	6.2	6.8	7.6	6.5	6.5	7.9	7.5	6.9	7.1	7.1		20
22	5	5.9	4.2	4.8	4.3	5.5	5	5.5	6.2	5.3	5.2	6.6	6.2	5.4	5.8	5.8		22
24	3.8	4.8	3.1	3.7	3.2	4.5	3.8	4.3	5.2	4.2	4.1	5.4	5.1	4.4	4.8	4.8		24
26	2.8	3.9	2.2	2.8	2.3	3.6	2.9	3.4	4.3	3.2	3.1	4.5	4.2	3.5	3.9	3.9		26
28	2.1	3.1	1.4	2	1.5	2.8	2.1	2.6	3.5	2.4	2.3	3.8	3.4	2.7	3.1	3.1		28
30	1.4	2.5		1.3		2.1	1.4	1.9	2.8	1.7	1.6	3.2	2.8	2	2.4	2.4		30
32		1.9				1.5		1.3	2.2			2.6	2.2	1.4	1.8	1.8		32
34		1.4							1.7			2.1	1.6		1.2	1.2		34
36									1.2			1.6						36
38																		38
40																		40
42																		42
44																		44
46																		46
48																		48
50																		50
52																		52
54																		54
56																		56
58																		58
60																		60
II	92	46	92	92	92	46	92	46		92	92		46	92	92	100	II	
III	46	46	92	92	92	46	92	92	92	92	92	92	92	92	92	100	III	
IV	46	46	46	46	92	92	92	92	92	92	92	92	92	92	92	100	IV	
V	46	46	46	46	46	92	46	92	92	92	92	92	92	92	92	100	V	
VI	46	46	46	46	46	92	46	92	92	46	92	92	92	92	92	100	VI	
VII	46	92		46			46		46	46		92	92	46	92	100	VII	
Number of parts of line	5	5	5	4	4	4	3	3	3	3	3	3	2	2	2	2	Number of parts of line	

Load Chart - Telescopic Boom

Unit: t

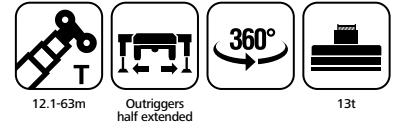

Radius (m)	12.1	16.1	20	24	27.8	31.8	35.5	Radius (m)
3	130	95	75					3
3.5	100	95	69	92	71			3.5
4	98	90	65	90	66.5	84	54.3	4
4.5	75.3	74	61	76	62.5	77	51.7	4.5
5	58.8	57.6	57	59.5	59	60.3	49.3	5
6	40	39	42	40.5	42.7	41.3	44	6
7	29.6	28.8	31.5	30.1	32	30.7	33	7
8	23	22.2	24.8	23.5	25.2	24	26.2	8
9	18.5	17.7	20.2	18.8	20.5	19.3	21.5	9
10		14.4	16.8	15.5	17.1	15.7	18	10
11		11.6	14.2	12.7	14.5	13	15.3	11
12		9.5	12.2	10.5	12.4	11	13.1	12
14				7.2	9.4	8	10.1	14
16				5.2	7.2	5.8	8	16
18						4.2	6.3	18
20								20
22						3.7	4.8	22
24						2.7	3.8	24
26								26
28								28
30								30
32								32
34								34
36								36
38								38
40								40
42								42
44								44
46								46
48								48
50								50
52								52
54								54
56								56
58								58
60								60
II		46						II
III				46		46		III
IV				46		46		IV
V				46	46	46		V
VI		46		46		46		VI
VII				46		46		VII
Number of parts of line	12	11	11	10	10	9	9	Number of parts of line

Load Chart - Telescopic Boom

Unit: t

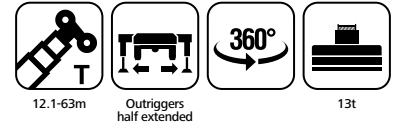

Radius (m)	39.5		43.4		47.4			51.3			55		58.9		63	Radius (m)	
3																3	
3.5																3.5	
4																4	
4.5																4.5	
5																5	
6																6	
7	31	29.5	30	31	29											7	
8	24.3	24.5	23.5	24.3	23.5	25										8	
9	19.7	20.8	19	19.7	19	20.4	19.5	20	21							9	
10	16.2	17.3	15.5	16.2	15.6	17	16	16.6	17.5	16.5	16.5	18				10	
11	13.6	14.7	13	13.7	13	14.3	13.5	14	15	14	13.9	15.3	14	14		11	
12	11.6	12.5	11	11.6	11	12.2	11.5	12	12.8	12	11.8	13.2	13	12.2	12	12	
14	8.6	9.5	7.8	8.5	8	9.2	8.5	9	9.7	8.8	8.8	10.1	9.8	9.1	9.5	9	14
16	6.4	7.3	5.5	6.2	5.8	7	6.3	6.7	7.5	6.6	6.5	8	7.6	7	7.2	7.2	16
18	4.7	5.6	3.8	4.5	4	5.3	4.5	5.1	5.9	5	4.8	6.3	5.9	5.3	5.5	5.5	18
20	3.4	4.3	2.6	3.2	2.7	4	3.3	3.8	4.7	3.7	3.5	5	4.6	4	4.2	4.3	20
22	2.3	3.3	1.5	2.1	1.6	2.9	2.2	2.8	3.6	2.6	2.5	4	3.6	2.9	3.2	3.2	22
24	1.4	2.4		1.2		2	1.4	1.9	2.7	1.7	1.6	3.1	2.7	2	2.3	2.3	24
26		1.7				1.3		1.2	2			2.4	2	1.3	1.6	1.6	26
28		1.1							1.4			1.8	1.3		1	1	28
30												1.2					30
32																	32
34																	34
36																	36
38																	38
40																	40
42																	42
44																	44
46																	46
48																	48
50																	50
52																	52
54																	54
56																	56
58																	58
60																	60
II	92	46	92	92	92	46	92	46		92	92		46	92	92	100	II
III	46	46	92	92	92	46	92	92	92	92	92	92	92	92	92	100	III
IV	46	46	46	46	92	92	92	92	92	92	92	92	92	92	92	100	IV
V	46	46	46	46	46	92	46	92	92	92	92	92	92	92	92	100	V
VI	46	46	46	46	46	92	46	92	92	46	92	92	92	92	92	100	VI
VII	46	92		46			46		46	46		92	92	46	92	100	VII
Number of parts of line	4	4	4	4	4	4	2	2	2	2	2	2	2	2	2	2	Number of parts of line

Load Chart - Telescopic Boom

Unit: t

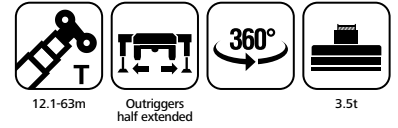

Radius (m)	12.1	16.1	20	24	27.8	31.8	35.5	Radius (m)
3	130	95	75					3
3.5	100	95	69	92	71			3.5
4	75	73	65	75	66	76	54.3	4
4.5	54.5	53	56	55	57.7	55.5	51.7	4.5
5	42	40.7	44.3	42	45	42.8	46	5
6	28	27	30	28	30.5	28.5	31.5	6
7	20	19	21.6	20.3	22.5	20.7	23.3	7
8	15	14.2	16.8	15.3	17.4	15.7	18.2	8
9	11.5	10.8	13.3	11.8	13.8	12.3	14.6	9
10		8.2	10.8	9.3	11.3	9.7	12	10
11		6.1	8.8	7.3	9.3	7.8	10	11
12			7.2	5.8	7.7	6.3	8.3	12
14				3.4	5.3	3.9	6.1	14
16					3.6	2.2	4.4	16
18						3.1	1.8	18
20							2	20
22								22
24								24
26								26
28								28
30								30
32								32
34								34
36								36
38								38
40								40
42								42
44								44
46								46
48								48
50								50
52								52
54								54
56								56
58								58
60								60
II		46						II
III				46		46		III
IV					46	46		IV
V						46	46	V
VI			46		46			VI
VII						46		VII
Number of parts of line	12	11	11	10	10	8	8	Number of parts of line

Load Chart - Telescopic Boom

Unit: t



Radius (m)	39.5		43.4			47.4			51.3			55		58.9		63	Radius (m)
3																	3
3.5																	3.5
4																	4
4.5																	4.5
5																	5
6																	6
7	21.5	22.5	20.5	21	20.5												7
8	16.5	17.7	15.6	16.5	16	17.3											8
9	13.1	14.1	12.2	13	12.5	13.7	13	13.5	14.5								9
10	10.6	11.5	9.6	10.3	10	11.2	10.5	11.1	12	10.6	10.5	12.2					10
11	8.6	9.5	7.7	8.3	8	9.2	8.5	9.1	9.9	8.6	8.6	10.2	9.8	9.1			11
12	7	8	6.2	6.8	6.4	7.5	7	7.5	8.3	7.1	7	8.6	8.2	7.6	7.6		12
14	4.6	5.7	3.9	4.5	4	5.2	4.6	5.1	5.9	4.7	4.6	6.3	5.9	5.2	5.4	5.2	14
16	2.8	4	2.1	2.7	2.2	3.5	2.9	3.4	4.2	2.9	2.9	4.6	4.2	3.5	3.7	3.6	16
18	1.6	2.7		1.4		2.2	1.6	2.1	3	1.8	1.6	3.3	2.9	2.1	2.5	2.3	18
20		1.7				1.2		1.1	1.9			2.3	1.9	1.1	1.4	1.3	20
22								1.1				1.5	1.1				22
24																	24
26																	26
28																	28
30																	30
32																	32
34																	34
36																	36
38																	38
40																	40
42																	42
44																	44
46																	46
48																	48
50																	50
52																	52
54																	54
56																	56
58																	58
60																	60
II	92	46	92	92	92	46	92	46		92	92		46	92	92	100	II
III	46	46	92	92	92	46	92	92	92	92	92	92	92	92	92	100	III
IV	46	46	46	46	92	92	92	92	92	92	92	92	92	92	92	100	IV
V	46	46	46	46	46	92	46	92	92	92	92	92	92	92	92	100	V
VI	46	46	46	46	46	92	46	92	92	46	92	92	92	92	92	100	VI
VII	46	92		46			46		46	46		92	92	46	92	100	VII
Number of parts of line	3	3	3	3	3	3	2	2	2	2	2	2	2	2	2	2	Number of parts of line

Load Chart - Telescopic Boom

Unit: t

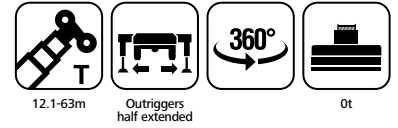

Radius (m)	12.1	16.1	20	24	27.8	31.8	35.5	Radius (m)
3	130	95	75					3
3.5	95	90	69	90	71			3.5
4	64	62.5	60	65	66.5	66	54.3	4
4.5	46	45	49	47	50	48	51	4.5
5	35	34.5	38	36	38.7	37	40	5
6	23	22	25.5	23.8	26	24.5	27	6
7	16	15	18.5	17	19	17.7	19.8	7
8	11.8	10.7	14	12.5	14.5	13.3	15.3	8
9	8.6	7.8	11	9.5	11.2	10.4	12.2	9
10		5.7	8.8	7.2	9	8.1	10	10
11		3.9	6.9	5.5	7.2	6.3	8.2	11
12		2.5	5.4	4	5.8	4.8	6.8	12
14				1.9	3.8	2.6	4.7	14
16					2.3	1.1	3.2	16
18							2.1	18
20								20
22								22
24								24
26								26
28								28
30								30
32								32
34								34
36								36
38								38
40								40
42								42
44								44
46								46
48								48
50								50
52								52
54								54
56								56
58								58
60								60
II		46						II
III				46		46		III
IV					46	46		IV
V						46	46	V
VI			46					VI
VII						46		VII
Number of parts of line	12	11	11	10	10	7	7	Number of parts of line

Load Chart - Telescopic Boom

Unit: t

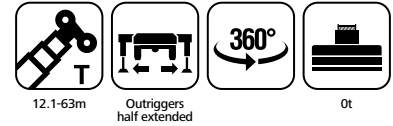

Radius (m)	39.5			43.4			47.4			51.3			55		58.9		63	Radius (m)
3																		3
3.5																		3.5
4																		4
4.5																		4.5
5																		5
6																		6
7	18	19	17	18	17.5													7
8	13.8	15	13	13.7	13	14.5												8
9	10.8	11.8	10	10.7	10.2	11.5	10.5	11.3	12.2									9
10	8.5	9.6	7.7	8.5	8	9.2	8.5	9.1	10	8.8	8.5	10.5						10
11	6.8	7.8	6	6.7	6.2	7.5	6.7	7.4	8.2	7	6.8	8.6	8	7.5				11
12	5.4	6.4	4.6	5.3	4.8	6.1	5.3	6	6.8	5.7	5.5	7.2	6.7	6	6.5			12
14	3.2	4.3	2.4	3.1	2.6	4	3.2	3.8	4.7	3.5	3.4	5.1	4.6	3.8	4.2	4.2		14
16	1.7	2.8		1.5		2.4	1.6	2.2	3.2	1.9	1.8	3.6	3.1	2.2	2.6	2.7		16
18		1.7							2			2.4	1.9	1	1.5	1.5		18
20												1.4						20
22																		22
24																		24
26																		26
28																		28
30																		30
32																		32
34																		34
36																		36
38																		38
40																		40
42																		42
44																		44
46																		46
48																		48
50																		50
52																		52
54																		54
56																		56
58																		58
60																		60
II	92	46	92	92	92	46	92	46		92	92		46	92	92	100		II
III	46	46	92	92	92	46	92	92	92	92	92	92	92	92	92	100		III
IV	46	46	46	46	92	92	92	92	92	92	92	92	92	92	92	100		IV
V	46	46	46	46	46	92	46	92	92	92	92	92	92	92	92	100		V
VI	46	46	46	46	46	92	46	92	92	46	92	92	92	92	92	100		VI
VII	46	92		46			46		46	46		92	92	46	92	100		VII
Number of parts of line	2	2	2	2	2	2	2	2	2	2	2	2	2	2	2	2		Number of parts of line

Load Chart - Telescopic Boom

Unit: t

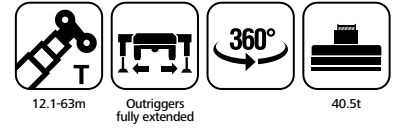

Radius (m)	12.1	16.1	20	24	27.8	31.8	35.5	Radius (m)
3	130	100	75					3
3.5	100	95	69	92	71			3.5
4	98	90.5	65	90	66.5	85	54.3	4
4.5	90	84	61	84.5	62.5	82	51.7	4.5
5	85	79	57	79	59	79	49.3	5
6	74	70	51	69.5	52.5	70	45.5	6
7	64	62	46	62	47.5	62	41.3	7
8	58	56	41.5	56.5	43	56	37.3	8
9	49	50	38.5	51.5	39.6	50	34.3	9
10		45	35.5	45	36.5	45	31.5	10
11		40	33	40	33.6	40.5	29.7	11
12		35	31	35.5	31.5	36.5	28	12
14			28.3	28	28.9	24.5	29.5	14
16			23	24.4	23.5	22	24	16
18				19.5	19.8	20.1	21	18
20					17.1	18	16	20
22					14.8	15.6	13.7	22
24						12.3	13.4	24
26						10.8	11.8	26
28							10	28
30							9	30
32								32
34								34
36								36
38								38
40								40
42								42
44								44
46								46
48								48
50								50
52								52
54								54
56								56
58								58
60								60
II		46				46	46	II
III			46	46	46	46	46	III
IV			46	46	46	46	46	IV
V			46	46	46	46	92	V
VI		46	46	46	46	46	46	VI
VII			46	46	46	46	92	VII
Number of parts of line	12	11	10	9	8	7	6	Number of parts of line

Load Chart - Telescopic Boom

Unit: t

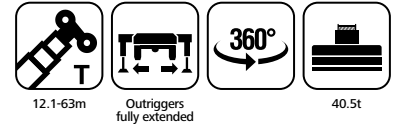

Radius (m)	39.5			43.4			47.4			51.3			55		58.9		63	Radius (m)	
3																		3	
3.5																		3.5	
4																		4	
4.5																		4.5	
5																		5	
6																		6	
7	41	29.5	39	32	32													7	
8	38	27.5	37	31	31	27.5												8	
9	35	25.8	35	29	29	25.6	25.6	23	21.5									9	
10	33	24.2	32.5	28	28	24	24.5	22	20	20.5	20.5	16.8						10	
11	31	22.7	30.5	26.5	26.5	22.5	23	20.5	19	19.5	19.5	16.1	15	17				11	
12	29	21.5	28.5	25	24.6	21	21.6	19.5	18	18.5	18.5	15.5	14.5	16.5	14			12	
14	25.5	19.2	25	22.2	22	19	19.3	17.5	16.5	16.5	16.8	14	13.5	15	13	11.2		14	
16	22.6	17.5	22	19.7	19.5	16.8	17.5	16	14.5	15.5	15.2	13	12.5	13.7	12	10.6		16	
18	19.5	15.8	19	18	17.5	15	15.8	14.5	13	14	14	11.7	11.5	12.6	11	10.1		18	
20	16.6	14.4	16	16.2	15.6	13.6	14.3	13	12	13	12.5	10.7	10.5	11.6	10.5	9.4		20	
22	14.3	13.2	13.7	14.2	13.9	12.5	13.2	11.7	11	12	11.5	10	10	10.7	9.7	8.8		22	
24	12.4	12.2	11.8	12.3	12	11.2	12	11	10.2	11	10.5	9.3	9.1	9.9	9	8.3		24	
26	10.8	11.5	10.2	10.8	10.4	10.2	10.8	10	9.5	10	10	8.5	8.5	9	8.5	7.7		26	
28	9.5	10.3	9	9.4	9.1	9.5	9.6	9.3	8.5	9.2	9	8	8	8.5	8	7.2		28	
30	8.4	9.2	7.8	8.3	8	8.8	8.4	8.5	8	8.5	8.5	7.3	7.3	8	7.5	6.8		30	
32	7.5	8.3	6.9	7.4	7	8	7.5	7.8	7.5	7.6	7.7	6.9	6.9	7.5	7	6.3		32	
34	6.7	7.4	6	6.5	6.2	7.1	6.7	7	7	6.8	6.8	6.5	6.4	7	6.5	5.9		34	
36				5.8	5.3	6.4	5.9	6.2	6.5	6.1	5.9	6.2	6	6.4	6	5.5		36	
38				5.1	4.6	5.8	5.1	5.5	6	5.4	5.2	5.7	5.6	5.7	5.5	5.1		38	
40							4.5	5	5.6	4.7	4.6	5.4	5.3	5.1	5	4.8		40	
42							3.9	4.4	5.1	4.1	4	5	5	4.5	4.6	4.5		42	
44										3.5	3.5	4.6	4.6	3.9	4.2	4.1		44	
46										3.1	3	4.2	4.2	3.4	3.7	3.7		46	
48													3.7	3	3.3	3.3		48	
50															2.9	2.9		50	
52															2.5	2.5		52	
54																2.3		54	
56																2		56	
58																		58	
60																		60	
II	92	46	92	92	92	46	92	46		92	92		46	92	92	100		II	
III	46	46	92	92	92	46	92	92	92	92	92	92	92	92	92	100		III	
IV	46	46	46	46	92	92	92	92	92	92	92	92	92	92	92	100		IV	
V	46	46	46	46	46	92	46	92	92	92	92	92	92	92	92	100		V	
VI	46	46	46	46	46	92	46	92	92	46	92	92	92	92	92	100		VI	
VII	46	92		46			46		46	46		92	92	46	92	100		VII	
Number of parts of line	5			4			3			3			2		2		2		Number of parts of line

Load Chart - Telescopic Boom

Unit: t

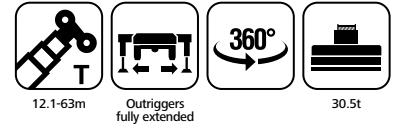

Radius (m)	12.1	16.1	20	24	27.8	31.8	35.5	Radius (m)
3	130	95	75					3
3.5	100	95	69	92	71			3.5
4	98	90	65	90	66.5	85	54.3	4
4.5	90	84	61	84	62.5	82	51.7	4.5
5	82	79	57	78	59	79	49.3	5
6	69.5	68.5	51	69	52.5	70	45.5	6
7	60	60	45.5	61.5	47.5	62	41.3	7
8	52	52.5	41	53.5	43	54	37.3	8
9	45	46	38	47	39.5	47	34	9
10		40	35	41.4	36	42	31	10
11		34	32.5	35.2	33.5	35.9	29.3	11
12		29.3	30.5	30.5	31	31.1	27.5	12
14				23.6	25.2	24.2	24.3	14
16				19	20.5	19.5	21.2	16
18						16.2	17.7	18
20						14.1	15	20
22						12.1	13	22
24								24
26								26
28								28
30								30
32								32
34								34
36								36
38								38
40								40
42								42
44								44
46								46
48								48
50								50
52								52
54								54
56								56
58								58
60								60
II		46				46	46	II
III			46	46	46	46	46	III
IV			46	46	46	46	46	IV
V				46	46	46	46	V
VI		46		46	46	46	46	VI
VII					46	46	46	VII
Number of parts of line	12	11	10	9	8	7	6	Number of parts of line

Load Chart - Telescopic Boom

Unit: t

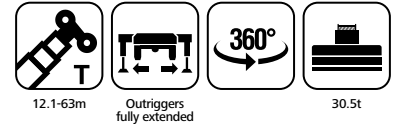

Radius (m)	39.5			43.4			47.4			51.3			55		58.9		63	Radius (m)	
3																		3	
3.5																		3.5	
4																		4	
4.5																		4.5	
5																		5	
6																		6	
7	41	29.5	39	32	32													7	
8	38	27.5	37	31	31	27.5												8	
9	35	25.8	35	29	29	25.6	25.6	23	21.5									9	
10	33	24.2	32.5	28	28	24	24.5	22	20	20.5	20.5	16.8						10	
11	31	22.7	30.5	26.5	26.5	22.5	23	20.5	19	19.5	19.5	16.1	15	17				11	
12	29	21.5	28.5	25	24.6	21	21.6	19.5	18	18.5	18.5	15.5	14.5	16.5	14			12	
14	24.5	19.2	23.8	22.2	22	19	19.3	17.5	16.5	16.5	16.8	14	13.5	15	13	11.2		14	
16	19.7	17.5	19.1	19	19	16.8	17.5	16	14.5	15.5	15.2	13	12.5	13.7	12	10.6		16	
18	16.3	15.8	15.7	16.2	15.9	15	15.8	14.5	13	14	14	11.7	11.5	12.6	11	10.1		18	
20	13.7	13.5	13.1	13.6	13.3	13.6	13.6	12.5	12	13	12.5	10.7	10.5	11.6	10.5	9.4		20	
22	11.6	12.5	11	11.6	11.2	12	11.7	11.2	10.5	11.5	11.2	9.5	10	10.7	9.7	8.8		22	
24	10	10.8	9.4	9.9	9.6	10.5	10	10.2	9.5	9.8	10	9	9.1	9.9	9	8.3		24	
26	8.6	9.4	8	8.5	8.2	9.2	8.7	9.1	9	8.8	8.8	8.4	8.5	9	8.5	7.7		26	
28	7.5	8.3	6.7	7.4	7	8	7.5	7.9	8.5	7.6	7.7	7.9	8	8	8	7.2		28	
30	6.4	7.3	5.7	6.3	6	7	6.5	6.9	7.5	6.6	6.6	7.3	7.3	7	7	6.7		30	
32	5.5	6.5	4.8	5.4	5	6.2	5.6	6	6.8	5.8	5.6	6.8	6.7	6.1	6.3	6.3		32	
34	4.6	5.8	4	4.6	4.2	5.5	4.7	5.2	6	5	4.8	6.2	6	5.3	5.5	5.5		34	
36				3.9	3.5	4.8	4	4.5	5.2	4.2	4.1	5.6	5.2	4.6	4.8	4.8		36	
38				3.2	2.8	4.2	3.3	3.8	4.7	3.6	3.5	5	4.6	4	4.2	4.2		38	
40							2.8	3.3	4.2	3	2.9	4.5	4	3.4	3.6	3.5		40	
42							2.3	2.8	3.7	2.5	2.4	4	3.5	2.9	3.1	3		42	
44										2	1.9	3.5	3	2.4	2.6	2.6		44	
46										1.6	1.5	3.1	2.6	1.9	2.2	2.2		46	
48													2.3	1.6	1.8	1.8		48	
50															1.5	1.5		50	
52																		52	
54																		54	
56																		56	
58																		58	
60																		60	
II	92	46	92	92	92	46	92	46		92	92		46	92	92	100		II	
III	46	46	92	92	92	46	92	92	92	92	92	92	92	92	92	100		III	
IV	46	46	46	46	92	92	92	92	92	92	92	92	92	92	92	100		IV	
V	46	46	46	46	46	92	46	92	92	92	92	92	92	92	92	100		V	
VI	46	46	46	46	46	92	46	92	92	46	92	92	92	92	92	100		VI	
VII	46	92		46			46		46	46		92	92	46	92	100		VII	
Number of parts of line	5			4			3			3			2		2		2		Number of parts of line

Load Chart - Telescopic Boom

Unit: t

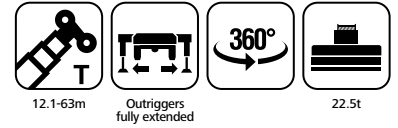

Radius (m)	12.1	16.1	20	24	27.8	31.8	35.5	Radius (m)
3	130	95	75					3
3.5	100	95	69	92	71			3.5
4	98	90	65	90	66.5	84	54.3	4
4.5	90	84	61	84	62.5	82	51.7	4.5
5	82	79	57	78	59	79	49.3	5
6	68	68	51	69	52.5	70	45.5	6
7	58	58.5	45.5	60	47	60	41.3	7
8	50	52	41.5	51.5	42.5	51	37.3	8
9	43	43.5	38.3	44.5	39	44	34.3	9
10		35.3	35.3	36.8	36	37.5	31.5	10
11		29.5	32	30.8	32.6	31.5	29.5	11
12		25	27.5	26.3	28	27	27.5	12
14			20	21.6	20.6	22.4	21.3	14
16			15.7	17.3	16.3	18	16.9	16
18				13.2	14.9	13.8	14.8	18
20					11.5	12.4	10.4	20
22					9.7	10.6	8.5	22
24						7.5	8.8	24
26						6.3	7.6	26
28							5.9	28
30							5	30
32								32
34								34
36								36
38								38
40								40
42								42
44								44
46								46
48								48
50								50
52								52
54								54
56								56
58								58
60								60
II		46				46	46	II
III			46	46	46	46	46	III
IV			46	46	46	46	46	IV
V				46	46	46	46	V
VI		46		46	46	46	46	VI
VII					46	46	46	VII
Number of parts of line	12	11	10	9	8	7	6	Number of parts of line

Load Chart - Telescopic Boom

Unit: t

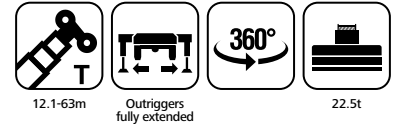

Radius (m)	39.5			43.4			47.4			51.3			55		58.9		63	Radius (m)	
3																		3	
3.5																		3.5	
4																		4	
4.5																		4.5	
5																		5	
6																		6	
7	41	29.5	39	32	32													7	
8	38	27.5	37	31	31	27.5												8	
9	35	25.8	35	29	29	25.6	25.6	23	21.5									9	
10	33	24.2	32.5	28	28	24	24.5	22	20	20.5	20.5	16.8						10	
11	30	22.7	30.5	26.5	26	22.5	23	20.5	19	19.5	19.5	16.1	15	17				11	
12	27	21.5	26.5	25	24.6	21	21.6	19.5	18	18.5	18.5	15.5	14.5	16.5	14			12	
14	20.8	19.2	20.1	20.8	20.4	19	19.3	17.5	16.5	16.5	16.8	14	13.5	15	13	11.2		14	
16	16.5	17.3	15.8	16.5	16	16.8	16.5	16	14.5	15.5	15.2	13	12.5	13.7	12	10.6		16	
18	13.4	14.3	12.8	13.3	13	14	13.5	14	13	13.5	13.5	11.7	11.5	12.6	11	10.1		18	
20	11	11.9	10.4	11	10.6	11.7	11.2	11.6	12	11.5	11.5	10.7	10.5	11.6	10.5	9.4		20	
22	9.2	10.1	8.6	9.2	8.8	9.8	9.3	9.8	10.5	9.8	9.5	10	10	9.9	9.7	8.8		22	
24	7.6	8.6	7.1	7.7	7.2	8.4	7.8	8.2	9	8.2	8	9	9	8.4	8.6	8.3		24	
26	6.4	7.4	5.8	6.3	5.9	7.2	6.5	7	7.7	6.9	6.7	8	7.8	7	7.4	7.3		26	
28	5.3	6.4	4.6	5.2	4.8	6.1	5.4	5.9	6.7	5.7	5.6	7	6.7	6	6.3	6.3		28	
30	4.4	5.5	3.7	4.3	3.8	5.1	4.4	5	5.8	4.7	4.6	6	5.8	5	5.4	5.3		30	
32	3.6	4.6	2.9	3.5	3	4.3	3.6	4.1	5	3.9	3.8	5.3	5	4.2	4.5	4.5		32	
34	2.9	4	2.2	2.8	2.3	3.6	2.9	3.4	4.2	3.2	3.1	4.6	4.2	3.5	3.8	3.8		34	
36				2.2	1.7	3	2.3	2.8	3.7	2.6	2.4	4	3.6	2.8	3.2	3.2		36	
38				1.7		2.5	1.8	2.3	3.2	2	1.9	3.5	3	2.3	2.6	2.6		38	
40								1.8	2.7	1.5	1.4	3	2.5	1.8	2.1	2.1		40	
42								1.4	2.3				2.5	2.1	1.3	1.7	1.7	42	
44													2.1	1.7		1.3	1.3	44	
46													1.4					46	
48																		48	
50																		50	
52																		52	
54																		54	
56																		56	
58																		58	
60																		60	
II	92	46	92	92	92	46	92	46		92	92		46	92	92	100		II	
III	46	46	92	92	92	46	92	92	92	92	92	92	92	92	92	100		III	
IV	46	46	46	46	92	92	92	92	92	92	92	92	92	92	92	100		IV	
V	46	46	46	46	46	92	46	92	92	92	92	92	92	92	92	100		V	
VI	46	46	46	46	46	92	46	92	92	46	92	92	92	92	92	100		VI	
VII	46	92		46			46		46	46		92	92	46	92	100		VII	
Number of parts of line	5			4			3			3			2		2		2		Number of parts of line

Load Chart - Telescopic Boom

Unit: t

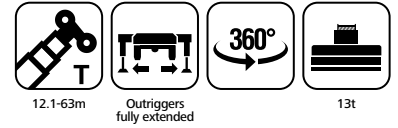

Radius (m)	12.1	16.1	20	24	27.8	31.8	35.5	Radius (m)
3	130	95	75					3
3.5	100	95	69	92	71			3.5
4	98	90	65	90	66.5	84	54.3	4
4.5	90	84	61	84	62.5	82	51.7	4.5
5	80	77	57	78	59	77	49.3	5
6	66	68	51	69	52.5	65	45.5	6
7	55	57	45.5	55	47	55	41.3	7
8	45	43.5	41.5	45.2	42.5	46	37.3	8
9	35	33.7	36.5	35.3	37	36	34.3	9
10		27.2	30	28.5	30.5	29.2	31	10
11		22.5	25	23.8	25.5	24.3	26.5	11
12		18.5	21.3	20	21.8	20.8	22.7	12
14			14.7	16.5	15.5	17.4	16.2	14
16			11	13	11.7	13.8	12.5	16
18				9	11.2	9.7	11	18
20					7.7	9	6.2	20
22					6.1	7.4	4.8	22
24						4.2	5.7	24
26						3.2	4.7	26
28							3.1	28
30							2.4	30
32								32
34								34
36								36
38								38
40								40
42								42
44								44
46								46
48								48
50								50
52								52
54								54
56								56
58								58
60								60
II		46				46	46	II
III			46	46	46	46	46	III
IV			46	46	46	46	46	IV
V			46	46	46	46	92	V
VI		46	46	46	46	46	46	VI
VII			46	46	46	46	92	VII
Number of parts of line	12	11	10	9	8	7	6	Number of parts of line

Load Chart - Telescopic Boom

Unit: t

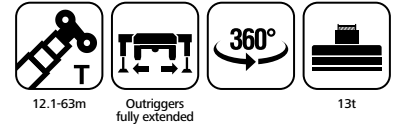

Radius (m)	39.5			43.4			47.4			51.3			55		58.9		63	Radius (m)	
3																		3	
3.5																		3.5	
4																		4	
4.5																		4.5	
5																		5	
6																		6	
7	41	29.5	39	32	32													7	
8	38	27.5	37	31	31	27.5												8	
9	34	25.8	33.5	29	29	25.6	25.6	23	21.5									9	
10	29.5	24.2	28.8	28	28	24	24.5	22	20	20.5	20.5	16.8						10	
11	24.6	22.7	24	24.7	24.2	22.5	23	20.5	19	19.5	19.5	16.1	15	17				11	
12	21	21.5	20.3	21	20.5	21	21	19.5	18	18.5	18.5	15.5	14.5	16.5	14			12	
14	15.8	16.8	15.1	15.8	15.3	16.5	16	16.5	16.5	16	16	14	13.5	15	13	11.2		14	
16	12.2	13.3	11.5	12.2	11.7	13	12.4	13	13.7	12.5	12.5	13	12.5	13	12	10.6		16	
18	9.7	10.7	8.8	9.5	9	10.3	9.6	10.2	11	10	9.8	11.2	11	10.3	10.6	10.1		18	
20	7.6	8.6	6.7	7.4	6.9	8.3	7.5	8.1	9	7.9	7.8	9.3	9	8.2	8.5	8.5		20	
22	6	7	5.1	5.8	5.3	6.6	5.9	6.4	7.3	6.2	6.2	7.7	7.4	6.6	6.9	6.9		22	
24	4.6	5.7	3.8	4.5	4	5.3	4.6	5.1	6	4.9	4.9	6.5	6.1	5.3	5.6	5.6		24	
26	3.5	4.6	2.8	3.4	3	4.2	3.5	4	4.9	3.8	3.8	5.4	5	4.2	4.5	4.5		26	
28	2.6	3.7	1.9	2.5	2.1	3.3	2.6	3.1	4	2.9	2.8	4.5	4	3.3	3.6	3.6		28	
30	1.9	3		1.8		2.6	1.9	2.4	3.3	2.2	2.1	3.7	3.3	2.5	2.8	2.8		30	
32	1.3	2.3				1.9	1.3	1.8	2.6	1.5	1.4	3.1	2.6	1.9	2.2	2.2		32	
34		1.8				1.4		1.2	2.1			2.5	2.1	1.3	1.6	1.7		34	
36									1.6			2	1.6		1.1	1.2		36	
38									1.2			1.6						38	
40																		40	
42																		42	
44																		44	
46																		46	
48																		48	
50																		50	
52																		52	
54																		54	
56																		56	
58																		58	
60																		60	
II	92	46	92	92	92	46	92	46		92	92		46	92	92	100		II	
III	46	46	92	92	92	46	92	92	92	92	92	92	92	92	92	100		III	
IV	46	46	46	46	92	92	92	92	92	92	92	92	92	92	92	100		IV	
V	46	46	46	46	46	92	46	92	92	92	92	92	92	92	92	100		V	
VI	46	46	46	46	46	92	46	92	92	46	92	92	92	92	92	100		VI	
VII	46	92		46			46		46	46		92	92	46	92	100		VII	
Number of parts of line	5			4			3			3			2		2		2		Number of parts of line

Load Chart - Telescopic Boom

Unit: t

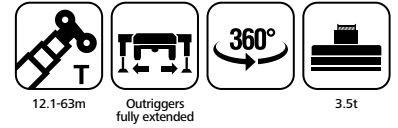

Radius (m)	12.1	16.1	20	24	27.8	31.8	35.5	Radius (m)
3	130	95	75					3
3.5	100	95	69	92	71			3.5
4	90	90	65	88	66.5	84	54.3	4
4.5	82	82	61	80	62.5	80	51.7	4.5
5	75	75	57	75	59	75	49.3	5
6	56	55	51	55	52	55	45.5	6
7	42.5	41.5	41.5	41.7	40	39.5	38.5	7
8	30.5	29.5	33.3	31.2	34	32	33	8
9	23	22	26	23.7	27	24.5	27.8	9
10		17	20.8	18.6	21.6	19.5	23	10
11		13.5	17	15	17.8	15.7	19	11
12			14	12.2	14.8	13	16	12
14				8.2	10.5	9.2	11.8	14
16				5.5	7.8	6.5	9	16
18					4.5	7	5.7	18
20						4.2	5.5	20
22						3	4.2	22
24							1.3	24
26							2	26
28								28
30								30
32								32
34								34
36								36
38								38
40								40
42								42
44								44
46								46
48								48
50								50
52								52
54								54
56								56
58								58
60								60
II		46				46	46	II
III			46	46	46	46	46	III
IV			46	46	46	46	46	IV
V				46	46	46	46	V
VI		46		46	46	46	46	VI
VII					46	46	46	VII
Number of parts of line	12	11	10	9	8	7	6	Number of parts of line

Load Chart - Telescopic Boom

Unit: t

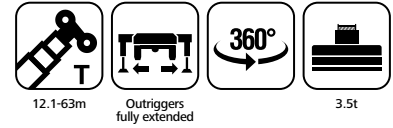

Radius (m)	39.5			43.4			47.4			51.3			55		58.9		63	Radius (m)	
3																		3	
3.5																		3.5	
4																		4	
4.5																		4.5	
5																		5	
6																		6	
7	38	29.5	37	30	30													7	
8	33	27.5	30	29	29	27.5												8	
9	25.5	25.2	25	23.8	23.2	25	24	23	21.5									9	
10	21	21.5	20.2	19.6	20	20.6	19.8	20.5	20	20	20.5	16.8						10	
11	17.2	18.1	16.5	16	16.6	17	16.2	16.8	18	16.5	17	16	14.5	15.5				11	
12	14.4	15.6	13.5	14.3	13.8	15.1	14.3	14.8	15.3	14.3	14.2	15.2	14	14.3	13			12	
14	10.2	11.5	9.5	10	9.6	11.1	10.5	10.8	11.7	10.5	10.5	11.7	11.2	10.9	10.8	9.5		14	
16	7.3	8.6	6.5	7.2	6.8	8.3	7.5	8	9	7.7	7.6	9.3	9	8.2	8.3	8.1		16	
18	5.3	6.6	4.5	5.2	4.8	6.2	5.4	6	6.9	5.6	5.5	7.3	6.9	6.1	6.3	6.5		18	
20	3.8	5	3	3.6	3.2	4.6	3.8	4.4	5.3	4	3.9	5.7	5.3	4.5	4.8	4.9		20	
22	2.6	3.7	1.8	2.4	2	3.4	2.6	3.1	4.1	2.8	2.7	4.5	4	3.3	3.6	3.7		22	
24	1.6	2.7		1.4		2.4	1.6	2.1	3.1	1.8	1.7	3.5	3	2.3	2.6	2.6		24	
26		1.9				1.6		1.3	2.3			2.6	2.2	1.4	1.8	1.8		26	
28		1.2							1.6			1.9	1.5			1.1		28	
30												1.3						30	
32																		32	
34																		34	
36																		36	
38																		38	
40																		40	
42																		42	
44																		44	
46																		46	
48																		48	
50																		50	
52																		52	
54																		54	
56																		56	
58																		58	
60																		60	
II	92	46	92	92	92	46	92	46		92	92		46	92	92	100		II	
III	46	46	92	92	92	46	92	92	92	92	92	92	92	92	92	100		III	
IV	46	46	46	46	92	92	92	92	92	92	92	92	92	92	92	100		IV	
V	46	46	46	46	46	92	46	92	92	92	92	92	92	92	92	100		V	
VI	46	46	46	46	46	92	46	92	92	46	92	92	92	92	92	100		VI	
VII	46	92		46			46		46	46		92	92	46	92	100		VII	
Number of parts of line	4			4			3			3			2		2		2		Number of parts of line

Load Chart - Telescopic Boom

Unit: t

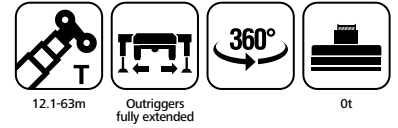

Radius (m)	12.1	16.1	20	24	27.8	31.8	35.5	Radius (m)
3	130	95	75					3
3.5	100	95	69	92	71			3.5
4	90	90	65	88	66.5	84	54.3	4
4.5	81	81	61	80	62.5	80	51.7	4.5
5	72	72	57	70	59	70	49.3	5
6	55	53	51	55	51	58	45.5	6
7	38	37.2	41	39	41	40	40	7
8	27	26.2	30	28	31	29.5	32.1	8
9	20	19.6	23	21.5	24	22.5	25.1	9
10		15	18.3	16.7	19.2	17.6	20.2	10
11		11.6	15	13.2	15.6	14.2	16.7	11
12		9	12.3	10.7	12.8	11.6	14.1	12
14			7	9.2	7.8	10.2	8.7	14
16			4.5	6.6	5.3	7.6	6.1	16
18				3.5	5.8	4.3	5.6	18
20					3	4.2	0	20
22						3.1		22
24							1.8	24
26							0	26
28								28
30								30
32								32
34								34
36								36
38								38
40								40
42								42
44								44
46								46
48								48
50								50
52								52
54								54
56								56
58								58
60								60
II		46				46	46	II
III			46	46	46	46	46	III
IV			46	46	46	46	46	IV
V			46	46	46	46	92	V
VI		46	46	46	46	46	46	VI
VII			46	46	46	46	92	VII
Number of parts of line	12	11	10	9	8	7	5	Number of parts of line

Load Chart - Telescopic Boom

Unit: t

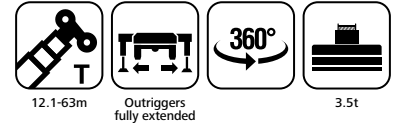

Radius (m)	39.5			43.4			47.4			51.3			55		58.9		63	Radius (m)	
3																		3	
3.5																		3.5	
4																		4	
4.5																		4.5	
5																		5	
6																		6	
7	36	29.5	36	29	28													7	
8	30	27.5	28.3	26	26.5	27.5												8	
9	22.8	24	21.7	22.5	22	23.6	22.5	22.5	21.5									9	
10	18	19.2	17.2	18	17.5	19	18	19	20	18.5	18.2	16.5						10	
11	14.5	15.8	13.7	14.5	14	15.5	14.6	15.5	16.5	15	15.2	15.8	14	15				11	
12	12	13.2	11.2	12	11.3	13	12.2	12.8	13.8	12.5	12.5	14.2	13.5	12.8	12			12	
14	8.4	9.5	7.4	8.1	7.6	9	8.3	9	10	8.7	8.6	10.5	9.8	9.1	9.5	9		14	
16	5.8	7	4.9	5.5	5.1	6.5	5.8	6.3	7.3	6.1	6	8	7.2	6.5	6.9	6.8		16	
18	4	5.1	3.1	3.8	3.3	4.7	3.9	4.4	5.5	4.2	4.2	6	5.4	4.6	5	5		18	
20	2.6	3.7	1.7	2.4	1.9	3.3	2.5	3.1	4	2.8	2.8	4.6	4	3.2	3.6	3.6		20	
22	1.5	2.6		1.3		2.2	1.4	2	2.9	1.7	1.6	3.4	2.9	2.1	2.5	2.5		22	
24		1.7				1.3		1.1	2.1			2.5	2	1.2	1.6	1.6		24	
26		1							1.3			1.8	1.3					26	
28												1.1						28	
30																		30	
32																		32	
34																		34	
36																		36	
38																		38	
40																		40	
42																		42	
44																		44	
46																		46	
48																		48	
50																		50	
52																		52	
54																		54	
56																		56	
58																		58	
60																		60	
II	92	46	92	92	92	46	92	46		92	92		46	92	92	100		II	
III	46	46	92	92	92	46	92	92	92	92	92	92	92	92	92	100		III	
IV	46	46	46	46	92	92	92	92	92	92	92	92	92	92	92	100		IV	
V	46	46	46	46	46	92	46	92	92	92	92	92	92	92	92	100		V	
VI	46	46	46	46	46	92	46	92	92	46	92	92	92	92	92	100		VI	
VII	46	92		46			46		46	46		92	92	46	92	100		VII	
Number of parts of line	4			3			3			2			2		2		2		Number of parts of line

Jib Operating Range

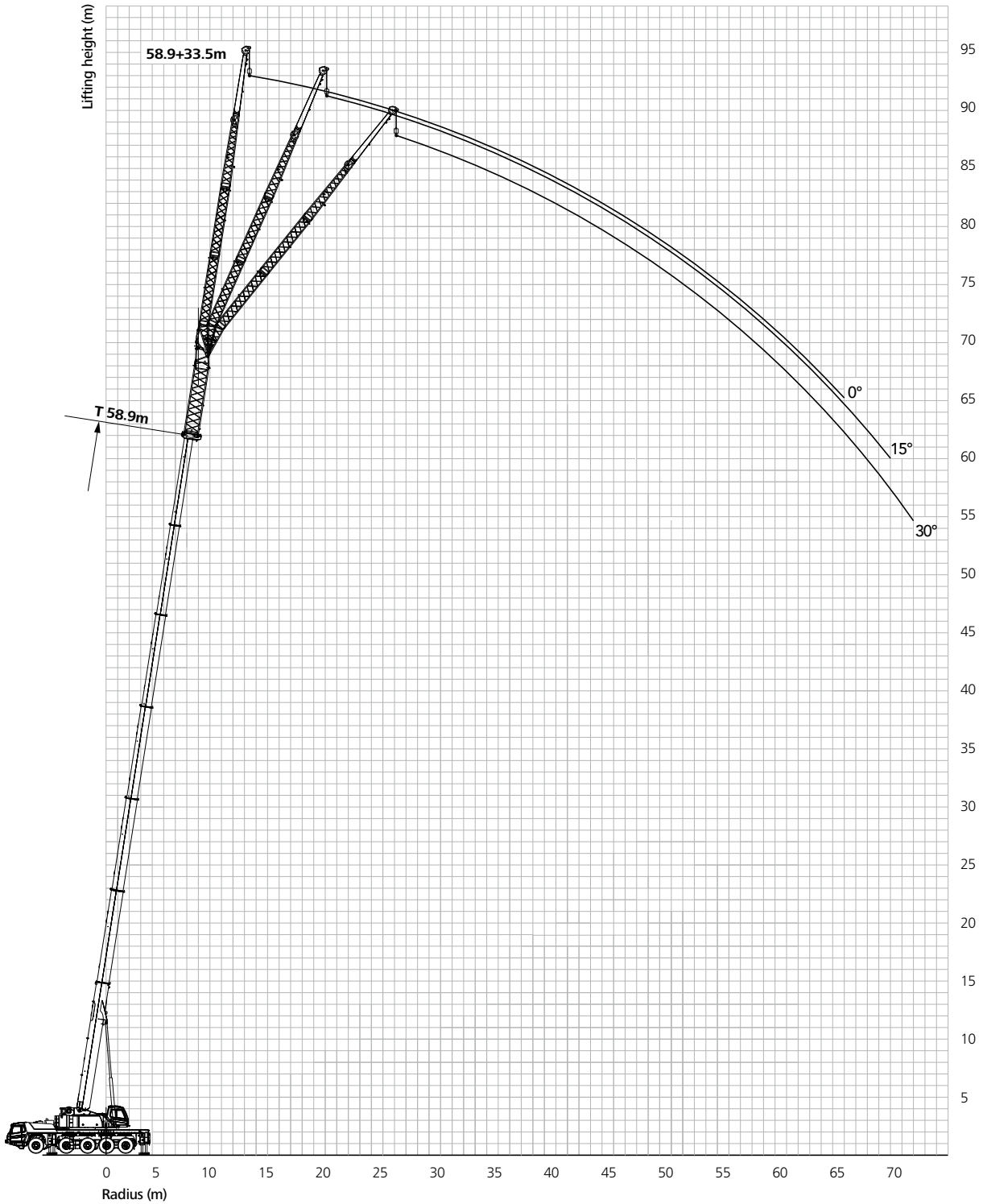

Load Chart - Fixed Jib

Unit: t

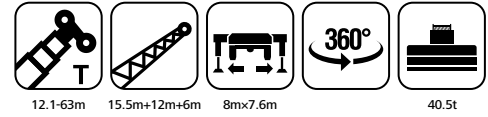

Radius (m)	47.4m			51.3m			55.2m			58.9m			Radius (m)
	15.5m+12m+6m			15.5m+12m+6m			15.5m+12m+6m			15.5m+12m+6m			
	0°	15°	30°	0°	15°	30°	0°	15°	30°	0°	15°	30°	
14													14
16	2.7												16
18	2.7			2.4			2.1			1.8			18
20	2.7			2.4			2.1			1.8			20
22	2.7	2.7		2.4			2.1			1.8			22
24	2.6	2.6		2.4	2.4		2.1	2.1		1.8			24
26	2.6	2.5		2.3	2.4		2.1	2.1		1.8	1.8		26
28	2.5	2.4	2.4	2.3	2.3		2	2.1		1.8	1.8		28
30	2.5	2.3	2.3	2.3	2.3	2.2	2	2.1	2	1.8	1.8		30
32	2.4	2.2	2.2	2.3	2.2	2.1	2	2	2	1.8	1.8	1.8	32
34	2.3	2.1	2.1	2.2	2.1	2.1	2	2	1.9	1.8	1.8	1.8	34
36	2.2	2.1	2	2.1	2	2	1.9	1.9	1.9	1.8	1.8	1.8	36
38	2.1	2	1.9	2	1.9	1.9	1.9	1.8	1.8	1.7	1.7	1.7	38
40	2	1.9	1.9	2	1.9	1.8	1.8	1.8	1.7	1.7	1.7	1.7	40
42	1.9	1.8	1.8	1.9	1.8	1.8	1.8	1.7	1.7	1.7	1.6	1.6	42
44	1.8	1.7	1.7	1.8	1.7	1.7	1.7	1.6	1.6	1.6	1.6	1.6	44
46	1.7	1.7	1.7	1.7	1.7	1.7	1.6	1.6	1.6	1.6	1.5	1.5	46
48	1.7	1.6	1.6	1.7	1.6	1.6	1.6	1.5	1.5	1.5	1.5	1.5	48
50	1.6	1.5	1.5	1.6	1.6	1.5	1.5	1.5	1.5	1.5	1.4	1.4	50
52	1.5	1.5	1.5	1.6	1.5	1.5	1.5	1.4	1.4	1.4	1.4	1.4	52
54	1.5	1.4	1.4	1.5	1.5	1.4	1.4	1.4	1.4	1.4	1.4	1.4	54
56	1.3	1.4	1.2	1.4	1.4	1.4	1.3	1.3	1.3	1.3	1.3	1.3	56
58	1.1	1.3	1	1.2	1.4	1.3	1.1	1.3	1.3	1.1	1.3	1.3	58
60	0.9	1.2	0.8	0.9	1.2	1.1	0.9	1.2	1.3	0.9	1.2	1.2	60
62	0.7	1	0.7	0.7	1	0.9	0.7	1	1.2	0.7	1.1	1.2	62
64	0.5	0.8	0.6	0.5	0.8	0.7	0.5	0.8	1	0.5	0.9	1.1	64
66		0.6			0.6	0.6		0.6	0.7		0.7	1	66
68									0.6		0.5	0.7	68
70												0.5	70
II	92	92	92	92	92	92	92	92	92	92	92	92	II
III	92	92	92	92	92	92	92	92	92	92	92	92	III
IV	92	92	92	92	92	92	92	92	92	92	92	92	IV
V	46	46	46	92	92	92	92	92	92	92	92	92	V
VI	46	46	46	46	46	46	92	92	92	92	92	92	VI
VII	46	46	46	46	46	46	46	46	46	92	92	92	VII

Load Chart - Fixed Jib

Unit: t

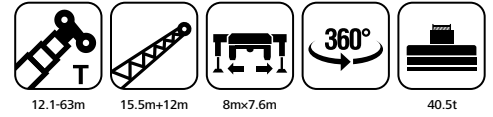

Radius (m)	47.4m			51.3m			55.2m			58.9m			63m			Radius (m)
	15.5m+12m			15.5m+12m			15.5m+12m			15.5m+12m			15.5m+12m			
	0°	15°	30°	0°	15°	30°	0°	15°	30°	0°	15°	30°	0°	15°	30°	
11	2.7															11
12	2.7			2.4			2.1									12
14	2.7			2.4			2.1			2.1			1.8			14
16	2.7			2.4			2.1			2.1			1.8			16
18	2.7	2.7		2.4	2.4		2.1			2.1			1.8			18
20	2.7	2.7		2.4	2.4		2.1	2.1		2.1	2.1		1.8	1.8		20
22	2.7	2.7		2.4	2.4		2.1	2.1		2.1	2.1		1.8	1.8		22
24	2.6	2.6	2.5	2.4	2.4	2.2	2.1	2.1		2.1	2.1		1.8	1.8		24
26	2.6	2.5	2.5	2.3	2.4	2.2	2.1	2.1	2	2.1	2.1	2	1.8	1.8	1.8	26
28	2.5	2.4	2.4	2.3	2.3	2.2	2	2.1	2	2.1	2.1	2	1.8	1.8	1.8	28
30	2.5	2.3	2.3	2.3	2.2	2.2	2	2.1	2	2	2.1	2	1.8	1.8	1.8	30
32	2.4	2.2	2.2	2.3	2.1	2.1	2	2	2	2	2.1	2	1.8	1.8	1.8	32
34	2.3	2.1	2.1	2.2	2	2.1	2	2	1.9	2	2	1.9	1.8	1.8	1.8	34
36	2.2	2.1	2	2.1	1.9	2	1.9	1.9	1.9	2	2	1.9	1.8	1.8	1.8	36
38	2.1	2	1.9	2	1.9	1.9	1.9	1.8	1.8	1.9	1.9	1.8	1.7	1.7	1.7	38
40	2	1.9	1.9	2	1.8	1.8	1.8	1.8	1.7	1.9	1.8	1.8	1.7	1.7	1.7	40
42	1.9	1.8	1.8	1.9	1.7	1.8	1.8	1.7	1.7	1.8	1.8	1.7	1.7	1.6	1.6	42
44	1.8	1.7	1.7	1.8	1.7	1.7	1.7	1.6	1.6	1.8	1.7	1.6	1.6	1.6	1.6	44
46	1.7	1.7	1.7	1.7	1.6	1.7	1.6	1.6	1.6	1.7	1.6	1.6	1.6	1.5	1.5	46
48	1.7	1.6	1.6	1.7	1.6	1.6	1.6	1.5	1.5	1.6	1.6	1.5	1.5	1.5	1.5	48
50	1.6	1.5	1.5	1.6	1.5	1.5	1.5	1.5	1.5	1.6	1.5	1.5	1.5	1.4	1.4	50
52	1.4	1.5	1.5	1.5	1.5	1.5	1.5	1.4	1.4	1.5	1.5	1.4	1.4	1.4	1.4	52
54	1.3	1.4	1.4	1.4	1.4	1.4	1.4	1.4	1.4	1.5	1.4	1.4	1.3	1.3	1.3	54
56	1.1	1.2	1.3	1.2	1.4	1.4	1.2	1.3	1.3	1.3	1.4	1.3	1.1	1.2	1.3	56
58	1	1.1	1.1	1.1	1.2	1.3	1	1.2	1.3	1.1	1.3	1.3	0.9	1.1	1.2	58
60	0.8	1	1	0.9	1	1.2	0.9	1.1	1.2	1	1.2	1.2	0.8	1	1	60
62	0.7	0.8	0.9	0.7	0.9	1	0.7	0.9	1	0.9	1	1.1	0.7	0.8	0.9	62
64	0.5	0.7	0.7	0.5	0.8	0.9	0.6	0.8	0.8	0.7	0.8	1	0.5	0.7	0.8	64
66		0.5	0.5		0.6	0.7		0.6	0.7	0.5	0.7	0.8		0.5	0.7	66
68						0.5		0.5	0.5		0.5	0.7			0.5	68
70												0.5				70
II	92	92	92	92	92	92	92	92	92	92	92	92	100	100	100	II
III	92	92	92	92	92	92	92	92	92	92	92	92	100	100	100	III
IV	92	92	92	92	92	92	92	92	92	92	92	92	100	100	100	IV
V	46	46	46	92	92	92	92	92	92	92	92	92	100	100	100	V
VI	46	46	46	46	46	46	92	92	92	92	92	92	100	100	100	VI
VII	46	46	46	46	46	46	100	100	100	46	46	46	92	92	92	VII

Load Chart - Fixed Jib

Unit: t

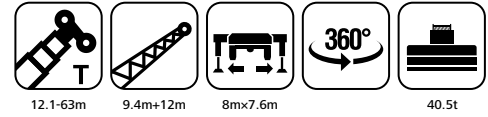

Radius (m)	47.4m			51.3m			55.2m			58.9m			63m			Radius (m)
	9.4m+12m			9.4m+12m			9.4m+12m			9.4m+12m			9.4m+12m			
	0°	15°	30°	0°	15°	30°	0°	15°	30°	0°	15°	30°	0°	15°	30°	
10	4															10
11	4			3.6			3.1									11
12	4			3.6			3.1			3.1						12
14	4			3.6			3.1			3.1						14
16	4	3.9		3.6	3.6		3.1			3.1			2.7			16
18	3.9	3.9		3.5	3.6		3.1	3.1		3.1	3.1		2.7			18
20	3.9	3.8	3.7	3.5	3.6		3.1	3.1		3.1	3.1		2.7	2.7		20
22	3.8	3.6	3.5	3.4	3.5	3.4	3.1	3.1	3.1	3.1	3.1	3.1	2.7	2.7		22
24	3.6	3.5	3.4	3.3	3.4	3.3	3.1	3.1	3	3.1	3.1	3.1	2.7	2.7	2.7	24
26	3.5	3.3	3.2	3.2	3.2	3.1	3	3	2.9	3.1	3.1	3	2.7	2.7	2.7	26
28	3.3	3.2	3.1	3.1	3.1	3	2.9	2.9	2.8	3	3	2.9	2.7	2.7	2.7	28
30	3.2	3	3	3	3	2.9	2.9	2.8	2.7	3	2.9	2.8	2.6	2.6	2.6	30
32	3	2.9	2.8	2.9	2.9	2.8	2.8	2.7	2.6	2.9	2.8	2.7	2.6	2.6	2.5	32
34	2.9	2.8	2.7	2.8	2.7	2.7	2.7	2.6	2.5	2.8	2.7	2.6	2.6	2.5	2.5	34
36	2.8	2.7	2.6	2.7	2.6	2.6	2.6	2.5	2.4	2.7	2.6	2.5	2.5	2.4	2.4	36
38	2.6	2.6	2.5	2.6	2.5	2.5	2.5	2.4	2.4	2.6	2.5	2.5	2.4	2.3	2.3	38
40	2.5	2.5	2.4	2.5	2.5	2.4	2.4	2.3	2.3	2.5	2.4	2.4	2.3	2.3	2.2	40
42	2.5	2.4	2.3	2.3	2.4	2.3	2.3	2.2	2.2	2.4	2.3	2.3	2.2	2.2	2.2	42
44	2.2	2.3	2.3	2.1	2.2	2.2	2.2	2.2	2.2	2.3	2.3	2.2	2	2.1	2.1	44
46	1.9	2.1	2.1	1.8	2	2	1.9	2.1	2.1	2.1	2.2	2.2	1.8	1.9	2	46
48	1.7	1.8	1.9	1.6	1.8	1.8	1.7	1.9	2	1.9	2	2.1	1.6	1.7	1.8	48
50	1.5	1.6	1.7	1.4	1.5	1.6	1.6	1.7	1.8	1.7	1.8	1.9	1.4	1.5	1.6	50
52	1.3	1.4	1.4	1.2	1.3	1.4	1.3	1.5	1.6	1.5	1.6	1.7	1.3	1.4	1.4	52
54	1.1	1.2	1.3	1	1.1	1.2	1.2	1.3	1.4	1.3	1.4	1.5	1.1	1.2	1.3	54
56	0.9	1.1	1.1	0.8	1	1	1	1.1	1.2	1.1	1.2	1.3	0.9	1.1	1.1	56
58	0.8	0.9	0.9	0.7	0.8	0.9	0.8	1	1	0.9	1	1.2	0.8	0.9	1	58
60	0.6	0.7	0.7	0.5	0.6	0.7	0.6	0.8	0.9	0.7	0.9	1	0.6	0.7	0.8	60
62		0.5	0.5		0.5	0.5		0.6	0.7	0.5	0.7	0.8		0.6	0.6	62
64									0.5			0.7			0.5	64
II	92	92	92	92	92	92	92	92	92	92	92	92	100	100	100	II
III	92	92	92	92	92	92	92	92	92	92	92	92	100	100	100	III
IV	92	92	92	92	92	92	92	92	92	92	92	92	100	100	100	IV
V	46	46	46	92	92	92	92	92	92	92	92	92	100	100	100	V
VI	46	46	46	46	46	46	92	92	92	92	92	92	100	100	100	VI
VII	46	46	46	46	46	46	46	46	46	92	92	92	100	100	100	VII

Load Chart - Fixed Jib

Unit: t

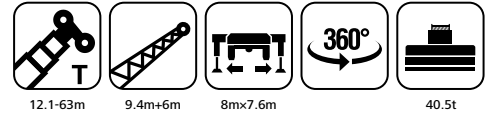

Radius (m)	47.4m			51.3m			55.2m			58.9m			63m			Radius (m)
	9.4m+6m			9.4m+6m			9.4m+6m			9.4m+6m			9.4m+6m			
	0°	15°	30°	0°	15°	30°	0°	15°	30°	0°	15°	30°	0°	15°	30°	
9	6															9
10	6			5.3			4.5									10
11	6			5.3			4.5			4.6						11
12	6			5.3			4.5			4.6			3.9			12
14	5.9	5.7		5.3	5.3		4.5	4.5		4.6			3.9			14
16	5.8	5.5	5.1	5.3	5.2		4.5	4.5		4.6	4.6		3.9	3.9		16
18	5.6	5.2	4.9	5.2	5	4.7	4.5	4.5	4.3	4.6	4.6	4.4	3.9	3.9		18
20	5.4	4.9	4.7	5.1	4.8	4.5	4.5	4.3	4.2	4.6	4.5	4.3	3.9	3.9	3.8	20
22	5.1	4.7	4.4	4.9	4.6	4.3	4.4	4.2	4.1	4.5	4.4	4.2	3.9	3.9	3.8	22
24	4.9	4.5	4.3	4.7	4.4	4.2	4.3	4.1	3.9	4.4	4.2	4.1	3.8	3.8	3.8	24
26	4.6	4.3	4.1	4.5	4.2	4	4.1	3.9	3.8	4.3	4.1	3.9	3.8	3.7	3.7	26
28	4.4	4.1	3.9	4.3	4.1	3.9	3.9	3.8	3.7	4.2	3.9	3.8	3.7	3.6	3.6	28
30	4.1	3.9	3.8	4.1	3.9	3.8	3.8	3.7	3.6	4	3.8	3.7	3.6	3.5	3.5	30
32	3.9	3.8	3.7	3.9	3.8	3.7	3.6	3.5	3.5	3.8	3.7	3.6	3.5	3.4	3.4	32
34	3.7	3.7	3.6	3.7	3.7	3.6	3.5	3.4	3.4	3.7	3.6	3.5	3.3	3.3	3.3	34
36	3.5	3.5	3.5	3.5	3.5	3.5	3.3	3.3	3.3	3.5	3.5	3.4	3.2	3.2	3.2	36
38	3.2	3.3	3.3	3.3	3.3	3.3	3.1	3.1	3.1	3.3	3.4	3.3	3	3	3	38
40	2.9	3	3.1	3	3	3	2.8	2.8	2.8	3.1	3.1	3.1	2.7	2.8	2.8	40
42	2.7	2.7	2.8	2.7	2.7	2.7	2.5	2.5	2.5	2.8	2.9	2.9	2.4	2.5	2.6	42
44	2.4	2.4	2.6	2.4	2.5	2.5	2.3	2.3	2.3	2.5	2.7	2.7	2.2	2.3	2.3	44
46	2.2	2.2	2.3	2.1	2.2	2.2	2	2	2	2.3	2.4	2.5	2	2.1	2.1	46
48	1.9	1.9	2	1.9	1.9	2	1.8	1.8	1.8	2	2.2	2.2	1.8	1.9	1.9	48
50	1.7	1.7	1.8	1.7	1.7	1.7	1.6	1.6	1.7	1.8	1.9	2	1.6	1.7	1.8	50
52	1.4	1.5	1.6	1.4	1.5	1.5	1.4	1.4	1.4	1.5	1.7	1.8	1.4	1.5	1.6	52
54	1.1	1.3	1.4	1.1	1.3	1.3	1.1	1.2	1.3	1.2	1.5	1.6	1.2	1.3	1.4	54
56	0.8	1	1	0.8	1	1.1	0.9	1	1.1	0.9	1.3	1.4	1.1	1.1	1.2	56
58	0.6	0.7	0.7	0.6	0.7	0.8	0.7	0.9	0.9	0.7	1	1.2	0.8	1	1.1	58
60					0.5	0.5	0.5	0.6	0.7	0.5	0.8	0.9	0.6	0.7	0.9	60
62											0.5	0.6		0.5	0.6	62
II	92	92	92	92	92	92	92	92	92	92	92	92	100	100	100	II
III	92	92	92	92	92	92	92	92	92	92	92	92	100	100	100	III
IV	92	92	92	92	92	92	92	92	92	92	92	92	100	100	100	IV
V	46	46	46	92	92	92	92	92	92	92	92	92	100	100	100	V
VI	46	46	46	46	46	46	92	92	92	92	92	92	100	100	100	VI
VII	46	46	46	46	46	46	46	46	46	92	92	92	100	100	100	VII

Load Chart - Fixed Jib

Unit: t

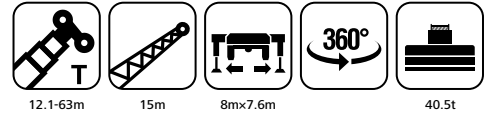

Radius (m)	31.8m			35.5m			39.5m			43.4m			47.4m			Radius (m)
	15.5m			15.5m			15.5m			15.5m			15.5m			
	0°	15°	30°	0°	15°	30°	0°	15°	30°	0°	15°	30°	0°	15°	30°	
6	5.8															6
7	5.6			5.3												7
8	5.5			5.3			5.1			4.9						8
9	5.4			5.2			5			4.8			4.9			9
10	5.2	4.2		5			4.9			4.6			4.8			10
11	5	4.2		4.8	4		4.8	4		4.5			4.8			11
12	4.8	4		4.6	3.9		4.6	4		4.4	3.9		4.6			12
14	4.6	3.9	3.5	4.4	3.8	3.4	4.5	3.9		4.2	3.8		4.5	3.9		14
16	4.4	3.8	3.4	4.3	3.7	3.3	4.3	3.8	3.4	4.1	3.7	3.3	4.4	3.8	3.3	16
18	4.2	3.7	3.3	4.1	3.6	3.3	4.2	3.7	3.3	4	3.6	3.3	4.2	3.7	3.3	18
20	4	3.6	3.3	4	3.5	3.2	4	3.6	3.3	3.9	3.5	3.2	4.1	3.6	3.2	20
22	3.9	3.5	3.2	3.8	3.5	3.2	3.9	3.5	3.2	3.8	3.5	3.2	4	3.6	3.2	22
24	3.8	3.4	3.2	3.7	3.4	3.2	3.8	3.4	3.2	3.7	3.4	3.2	3.9	3.5	3.2	24
26	3.6	3.4	3.2	3.6	3.3	3.2	3.7	3.4	3.2	3.7	3.3	3.2	3.8	3.4	3.2	26
28	3.5	3.3	3.2	3.4	3.3	3.2	3.6	3.3	3.2	3.6	3.3	3.2	3.7	3.4	3.2	28
30	3.3	3.3	3.2	3.3	3.3	3.2	3.5	3.3	3.2	3.5	3.3	3.1	3.6	3.3	3.1	30
32	3.1	3.2	3.2	3.2	3.2	3.2	3.4	3.3	3.2	3.4	3.2	3.1	3.5	3.3	3.1	32
34	3	3.2	3.2	3	3.2	3.2	3.3	3.2	3.2	3.3	3.2	3.1	3.4	3.2	3.1	34
36	2.8	3.1	3.2	2.9	3.1	3.2	3.2	3.2	3.2	3.2	3.2	3.1	3.3	3.2	3.1	36
38	2.7	3	3.1	2.8	3.1	3.1	3	3.1	3.2	3.1	3.1	3.1	3.2	3.2	3.1	38
40	2.6	2.8	3.1	2.7	2.9	2.8	2.9	3	3.1	3	3	3.1	3.1	3.2	3.1	40
42	2.5	2.6		2.5	2.6	2.5	2.8	2.8	2.9	2.9	2.9	3	3	3.1	3.1	42
44				2.1	2.2	2.2	2.7	2.5	2.7	2.7	2.7	2.8	2.9	2.9	2.9	44
46				1.7	1.8	1.9	2.4	2.3	2.4	2.5	2.5	2.6	2.6	2.6	2.6	46
48				1.3	1.4		2.1	2.1	2.2	2.2	2.3	2.4	2.4	2.4	2.4	48
50							1.8	1.9	2	2	2	2.1	2	2.2	2.2	50
52							1.5	1.7		1.8	1.8	1.9	1.7	1.9	2	52
54										1.5	1.6	1.7	1.4	1.6	1.7	54
56										1.3	1.3		1.1	1.3	1.3	56
58													0.9	1	1	58
60													0.7	0.7		60
62																62
64																64
66																66
II	46	46	46	46	46	46	92	92	92	92	92	92	92	92	92	II
III	46	46	46	46	46	46	46	46	46	92	92	92	92	92	92	III
IV	46	46	46	46	46	46	46	46	46	46	46	46	92	92	92	IV
V	46	46	46	46	46	46	46	46	46	46	46	46	46	46	46	V
VI	46	46	46	46	46	46	46	46	46	46	46	46	46	46	46	VI
VII	0	0	0	46	46	46	46	46	46	46	46	46	46	46	46	VII

Load Chart - Fixed Jib

Unit: t

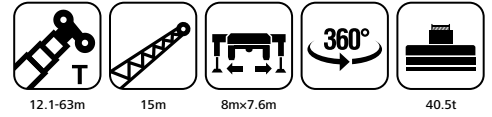

Radius (m)	51.3m			55.2m			58.9m			63m			Radius (m)
	15.5m			15.5m			15.5m			15.5m			
	0°	15°	30°	0°	15°	30°	0°	15°	30°	0°	15°	30°	
6													6
7													7
8													8
9													9
10	3.9			3.9									10
11	3.8			3.8			3.9						11
12	3.8			3.8			3.8			3.5			12
14	3.8	3.7		3.7	3.5		3.8			3.5			14
16	3.7	3.6		3.7	3.4		3.7	3.5		3.4	3.2		16
18	3.6	3.6	3.2	3.6	3.4	3.1	3.7	3.4	3.2	3.4	3.2		18
20	3.6	3.5	3.2	3.6	3.3	3.1	3.6	3.4	3.1	3.4	3.2	3.1	20
22	3.5	3.5	3.2	3.5	3.3	3.1	3.6	3.4	3.1	3.4	3.2	3.1	22
24	3.5	3.4	3.2	3.5	3.3	3.1	3.5	3.3	3.1	3.3	3.1	3.1	24
26	3.4	3.3	3.1	3.4	3.2	3.1	3.5	3.3	3.1	3.3	3.1	3.1	26
28	3.4	3.3	3.1	3.4	3.2	3.1	3.4	3.2	3.1	3.2	3.1	3.1	28
30	3.3	3.3	3.1	3.3	3.2	3.1	3.4	3.2	3.1	3.2	3.1	3.1	30
32	3.3	3.2	3.1	3.3	3.1	3.1	3.3	3.2	3.1	3.2	3.1	3.1	32
34	3.3	3.2	3.1	3.3	3.1	3.1	3.3	3.2	3.1	3.1	3	3.1	34
36	3.2	3.2	3.1	3.2	3.1	3.1	3.3	3.1	3.1	3.1	3	3.1	36
38	3.1	3.2	3.1	3.1	3	3	3.2	3.1	3.1	3	3	3	38
40	3	3.1	3.1	3	2.9	2.9	3.1	3.1	3.1	3	2.9	3	40
42	2.8	3.1	3.1	2.8	2.8	2.7	3	3	3.1	2.8	2.8	2.9	42
44	2.7	2.8	2.8	2.6	2.6	2.6	2.9	2.9	2.9	2.6	2.6	2.7	44
46	2.5	2.5	2.6	2.4	2.4	2.4	2.6	2.7	2.8	2.4	2.4	2.4	46
48	2.2	2.3	2.3	2.1	2.2	2.2	2.4	2.5	2.6	2.2	2.2	2.3	48
50	2	2	2.1	1.9	2	2	2.1	2.3	2.4	2	2.1	2.1	50
52	1.7	1.8	1.9	1.7	1.8	1.8	2	2	2.1	1.7	1.9	1.9	52
54	1.4	1.6	1.7	1.5	1.6	1.6	1.7	1.9	1.9	1.6	1.6	1.8	54
56	1.2	1.3	1.4	1.2	1.4	1.4	1.4	1.6	1.7	1.3	1.5	1.5	56
58	0.9	1.1	1.1	1	1.2	1.2	1.1	1.3	1.5	1.1	1.3	1.4	58
60	0.7	0.8	0.8	0.8	0.9	1	0.9	1.1	1.2	0.8	1	1.2	60
62	0.5	0.6	0.6	0.6	0.7	0.7	0.7	0.8	0.9	0.6	0.8	0.9	62
64						0.5	0.5	0.6	0.7		0.6	0.7	64
66									0.5				66
II	92	92	92	92	92	92	92	92	92	100	100	100	II
III	92	92	92	92	92	92	92	92	92	100	100	100	III
IV	92	92	92	92	92	92	92	92	92	100	100	100	IV
V	92	92	92	92	92	92	92	92	92	100	100	100	V
VI	46	46	46	92	92	92	92	92	92	100	100	100	VI
VII	46	46	46	46	46	46	92	92	92	100	100	100	VII

Load Chart - Fixed Jib

Unit: t

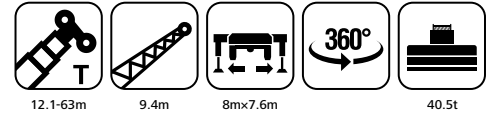

Radius (m)	31.8m			35.5m			39.5m			43.4m			47.4m			Radius (m)
	9.4m			9.4m			9.4m			9.4m			9.4m			
	0°	15°	30°	0°	15°	30°	0°	15°	30°	0°	15°	30°	0°	15°	30°	
6	8			8												6
7	8	8		8			8									7
8	8	8		8	7.9		8			8						8
9	8	8	7.8	8	7.9		8	8		8			8			9
10	8	8	7.8	7.9	7.9	7.9	8	8		8			8			10
11	8	7.8	7.8	7.9	7.8	7.9	8	8	7.9	7.9	8		8	8		11
12	7.9	7.8	7.8	7.9	7.8	7.7	8	7.9	7.9	7.9	8		7.9	7.9		12
14	7.9	7.8	7.6	7.8	7.7	7.7	7.9	7.9	7.8	7.8	7.9	7.9	7.9	7.9	7.8	14
16	7.9	7.8	7.6	7.8	7.7	7.5	7.9	7.8	7.8	7.8	7.9	7.9	7.9	7.8	7.8	16
18	7.9	7.6	7.6	7.8	7.5	7.5	7.8	7.8	7.8	7.5	7.8	7.6	7.8	7.8	7.6	18
20	7.8	7.6	7.6	7.6	7.5	7.3	7.8	7.5	7.4	7.5	7.7	7.6	7.8	7.6	7	20
22	7.8	7.6	7.4	7.6	7.3	7.3	7.4	6.9	6.7	7.2	7.7	7.1	7.6	7	6.3	22
24	7.8	7.6	7.4	7.6	7.3	7.2	6.8	6.3	6	6.5	6.9	6.5	7	6.3	5.8	24
26	7.8	7.6	7.4	7.6	7.1	6.6	6.3	5.8	5.5	5.8	6.3	5.9	6.2	5.7	5.3	26
28	7	6.8	6.6	7.1	6.4	5.9	5.7	5.2	4.9	5.4	5.7	5.4	5.5	5.1	4.8	28
30	6	6.1	5.9	6.4	5.8	5.4	5.1	4.7	4.5	4.9	5.2	4.9	5	4.6	4.4	30
32	4.7	5.4	5.2	5.6	5.2	5	4.5	4.3	4.1	4.4	4.6	4.5	4.5	4.2	4	32
34	3.4	4.5	4.5	4.9	4.7	4.5	4.1	3.8	3.7	3.9	4.2	4	4	3.8	3.7	34
36	2.5	3.6	3.8	4.2	4.1	4	3.6	3.5	3.3	3.7	3.8	3.6	3.6	3.5	3.3	36
38	2	2.7	3.1	3.5	3.5	3.5	3.2	3.1	3	3.3	3.4	3.3	3.2	3.1	3	38
40				2.8	2.9	3	2.9	2.8	2.7	3.1	3	3	2.9	2.7	2.7	40
42				2.1	2.3	2.5	2.5	2.5	2.4	2.8	2.8	2.7	2.6	2.5	2.4	42
44							2.2	2.2	2.1	2.5	2.4	2.4	2.3	2.2	2.2	44
46							1.8	1.8	1.7	2.3	2.2	2.2	2	1.9	1.9	46
48										1.9	1.9	2	1.7	1.7	1.7	48
50										1.5	1.6	1.5	1.4	1.5	1.4	50
52													1.1	1.2	1.2	52
54													0.9	0.9	0.8	54
56																56
58																58
60																60
II	46	46	46	46	46	46	92	92	92	92	92	92	92	92	92	II
III	46	46	46	46	46	46	46	46	46	92	92	92	92	92	92	III
IV	46	46	46	46	46	46	46	46	46	46	46	46	92	92	92	IV
V	46	46	46	46	46	46	46	46	46	46	46	46	46	46	46	V
VI	46	46	46	46	46	46	46	46	46	46	46	46	46	46	46	VI
VII	0	0	0	46	46	46	46	46	46	46	46	46	46	46	46	VII

Load Chart - Fixed Jib

Unit: t

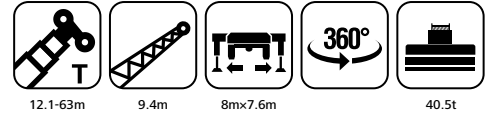

Radius (m)	51.3m			55.2m			58.9m			63m			Radius (m)
	9.4m			9.4m			9.4m			9.4m			
	0°	15°	30°	0°	15°	30°	0°	15°	30°	0°	15°	30°	
6													6
7													7
8													8
9													9
10	8			6.7									10
11	8			6.7			6.8						11
12	8	8		6.7			6.8			5.7			12
14	7.9	7.9	0	6.7	6.5		6.8	6.7		5.7			14
16	7.9	7.8	7.7	6.7	6.5	6.2	6.7	6.7	6.4	5.7	5.6		16
18	7.9	7.7	7.5	6.5	6.4	6	6.5	6.4	6.3	5.7	5.6	5.4	18
20	7.4	7.2	7	6.2	6.1	5.7	6.3	6.1	6.1	5.7	5.5	5.4	20
22	7	6.8	6.4	5.9	5.8	5.4	6	5.9	5.8	5.6	5.4	5.4	22
24	6.5	6.4	5.9	5.6	5.5	5.2	5.7	5.6	5.5	5.4	5.2	5.2	24
26	5.9	5.8	5.4	5.3	5.2	4.9	5.3	5.3	5.3	5.3	5	5	26
28	5.4	5.2	4.9	5	5	4.7	5	5	5	4.9	4.8	4.7	28
30	4.8	4.8	4.5	4.7	4.7	4.5	4.7	4.7	4.8	4.5	4.5	4.4	30
32	4.3	4.3	4.1	4.3	4.4	4.2	4.5	4.5	4.5	4.2	4.2	4.1	32
34	4	3.9	3.7	3.9	4.2	4	4.3	4.2	4.3	3.9	3.9	3.8	34
36	3.6	3.5	3.4	3.5	3.8	3.8	4	4	4	3.5	3.6	3.6	36
38	3.3	3.1	3.1	3.1	3.4	3.4	3.6	3.7	3.7	3.2	3.2	3.3	38
40	2.9	2.8	2.8	2.8	3.1	3.1	3.3	3.4	3.4	2.9	2.9	3	40
42	2.5	2.5	2.5	2.6	2.8	2.8	3	3.1	3.1	2.7	2.7	2.7	42
44	2.3	2.2	2.2	2.2	2.6	2.6	2.7	2.8	2.8	2.5	2.5	2.5	44
46	2	2	2	2	2.3	2.3	2.4	2.5	2.6	2.2	2.3	2.3	46
48	1.7	1.7	1.7	1.8	2.1	2.1	2.2	2.2	2.3	1.9	2	2.1	48
50	1.5	1.5	1.5	1.5	1.8	1.8	1.8	2	2.1	1.8	1.8	1.8	50
52	1	1	1	1.3	1.4	1.5	1.5	1.6	1.7	1.4	1.6	1.7	52
54	0.9	1	1	1	1.1	1.2	1.2	1.3	1.4	1.1	1.3	1.4	54
56	0.6	0.7	0.7	0.7	0.8	0.9	0.9	1	1.1	0.9	1	1.1	56
58				0.5	0.6	0.6	0.7	0.8	0.8	0.6	0.7	0.8	58
60								0.5	0.6		0.5	0.6	60
II	92	92	92	92	92	92	92	92	92	100	100	100	II
III	92	92	92	92	92	92	92	92	92	100	100	100	III
IV	92	92	92	92	92	92	92	92	92	100	100	100	IV
V	92	92	92	92	92	92	92	92	92	100	100	100	V
VI	46	46	46	92	92	92	92	92	92	100	100	100	VI
VII	46	46	46	46	46	46	92	92	92	100	100	100	VII



Sany Automobile Hoisting Machinery Co., Ltd.

No.168, Jinzhou Avenue, Jinzhou Development Zone, Changsha, Hunan, China

Postcode: 410600

Service: 0086-400 6098 318 Consulting: 400 8879 318

Email: crd@sany.com.cn

— Authorised Dealer —

Reminder:

For safe and reliable operation of the diesel engines, please fill Grade IV machines with Grade IV diesel and urea solution conforming to related national standards. Please refer to the operating instructions and related standards for details.

Any change in the technical parameters and configuration due to advancement in technology may occur without prior notice. The machine in the figures may include auxiliary equipment. This brochure is for reference only, and goods in kind shall prevail.

Copyright at Sany Heavy Industry. No part of this catalogue may be copied, recorded or used for any purpose without written approval from Sany Heavy Industry.

© Printed in August 2019 in China

www.sanyglobal.com

